



NOVO

Building Products



MOULDINGS | SHEET GOODS | BOARDS | EXTERIOR MILLWORK
CHANNAHON DISTRIBUTION CENTER

our STORY

DEEP ROOTS. HIGH STANDARDS. BRIGHT FUTURE.

Founded in 1946, Novo Building Products (previously known as Empire Moulding & Millwork) has grown into one of the largest millwork distribution and manufacturing

companies in the United States. With a geographic footprint that touches the majority of the eastern half of the United States, Novo Building Products is positioned for continued expansion.

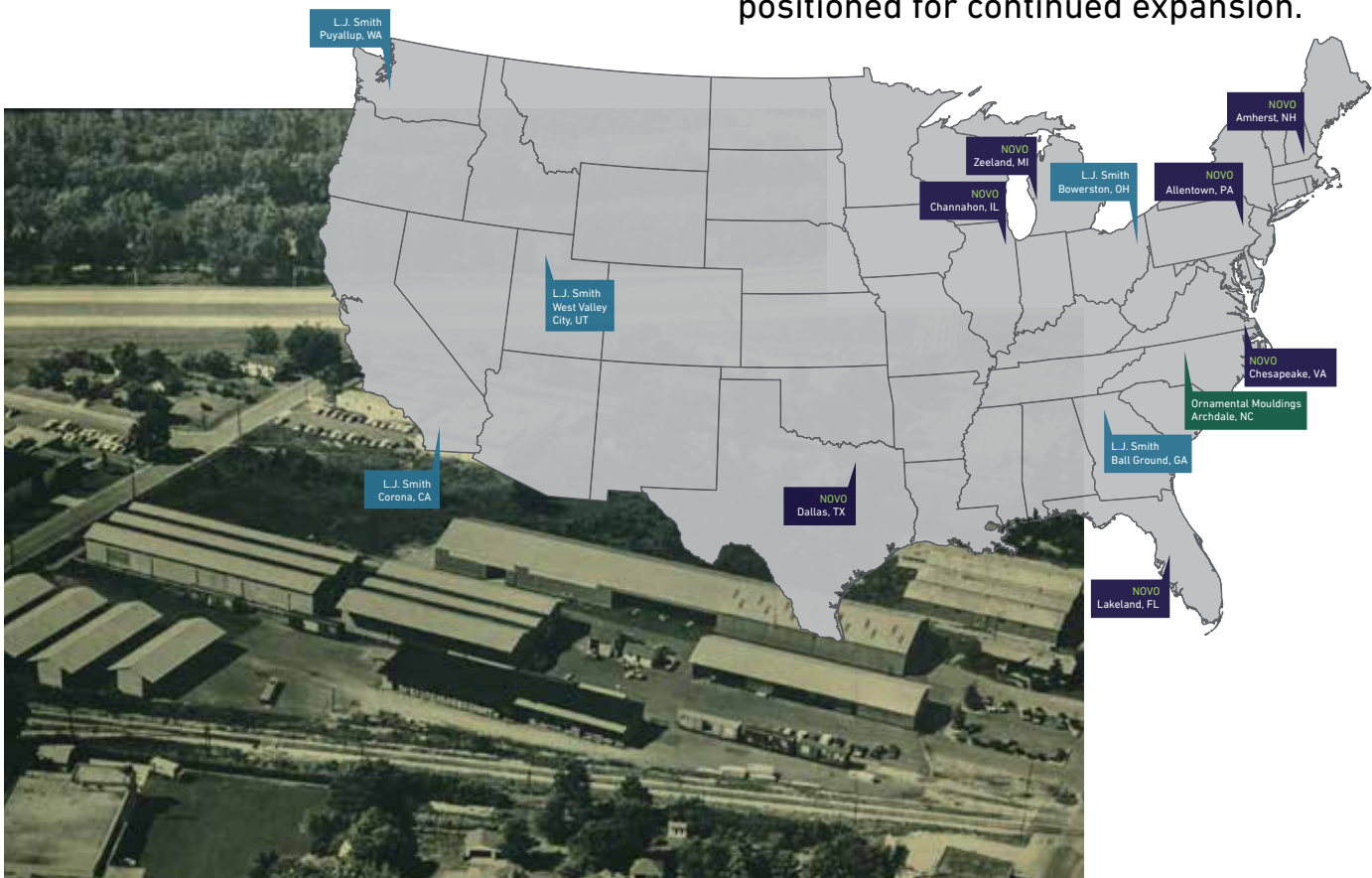

our

FAMILY

NOVO BUILDING PRODUCTS IS PROUD TO BE PART OF THE ADENTRA FAMILY.



Novo Building Products is an industry leading manufacturer and distributor of mouldings, stair parts, doors, and specialty building products. We serve building material dealers (lumberyards), door shops, retail home centers, and millwork manufacturing partners throughout the United States and parts of Canada and Mexico.

Learn more at NOVOBP.COM.

ADENTRA is one of North America's largest distributors of architectural-grade building and millwork products to the residential and commercial construction industries. Adentra currently operates a network of 86 distribution and fabrication facilities in North America consisting of five industry leading distribution brands: Hardwoods Specialty Products, Mid-Am Supply, Frank Paxton Lumber Company, Rugby Architectural Building Products, and Novo Building Products.

Learn more at ADENTRAgroup.com.





THE NEW & IMPROVED **NOVO PRODEALER PORTAL**



24/7 access to stocked product pricing



Easily place orders on a desktop or mobile device



Order status updates

BRAND NEW FEATURES!

- Invoice Lookup
- Product Filters
- Instant Account Verification
- Intercompany User Management
- Out-of-Stock Flag
- Full Product Catalog



Use your existing credentials to access the new ProDealer Portal

Don't have an account? Follow the steps below to sign up today!

pro.novobp.com

1. Locate your Customer Code from the "Ship To" line on your order acknowledgment.
2. Navigate to novobp.com. Click on Dealer Login. Select "Create An Account".
3. Fill in all fields marked with "Required" and select "Create Account".
4. Explore the new online portal.

Style is individual, personal, and unique.
Make your room a reflection of you...

DISTINGUISH YOUR STYLE



TABLE OF CONTENTS

INSPIRATION	6-13	DOOR JAMBS	34
DECORATIVE MOULDING ACCESSORIES.....	14-16	BASE BLOCKS BASE CAPS	35
BUILD-UPS	17	BASE	36-44
CUSTOM MANUFACTURING.....	18	CHAIR RAIL PANEL MOULD.....	45
SHEET GOODS	19-21	WAINSCOTING SHIPLAP	46
BOARDS	22	COVE BED	47
SPECIES DEFINITIONS GENERAL GRADE / REQUIREMENTS.....	23	CROWN.....	47-52
CASING.....	24-29	CROWN BLOCKS.....	53
CASING BLOCKS.....	30	GENERAL PURPOSE	54-55
ARCHITRAVES.....	31	PVC MOULDING	56-57
STOPS MULLIONS.....	32	MOULDING INDEX	58
BACK BANDS BRICKS STOOLS.....	33	QUALITY PRODUCTS.....	59



The mouldings listed may not be as shown in the image but are **041 Crown** | **P 450 (Casing) Chair Rail** | **5030 Architrave** | **312 Casing** | **L 163E Base** represented to achieve a similar style or look:

Traditional

Ranch, Classic, Colonial, Early American, inviting and timeless...

Traditional Mouldings enhance any home style from Midwestern, Early American to Coastal. They blend perfectly with the classic style furnishing and timeless building materials of today. NOVO has a vast selection of traditional style mouldings to match and enhance your own unique style.



**P 450 (CASING)
CHAIR RAIL**
11/16 x 3-1/2



**041
CROWN**
1-3/16 x 6-5/16



**5030
ARCHITRAVE**
1-3/16 x 6-1/4



**312
CASING**
19/32 x 3



**L 163E
BASE**
9/16 x 5-1/4

PROFILES SHOWN ARE NOT TO SCALE.

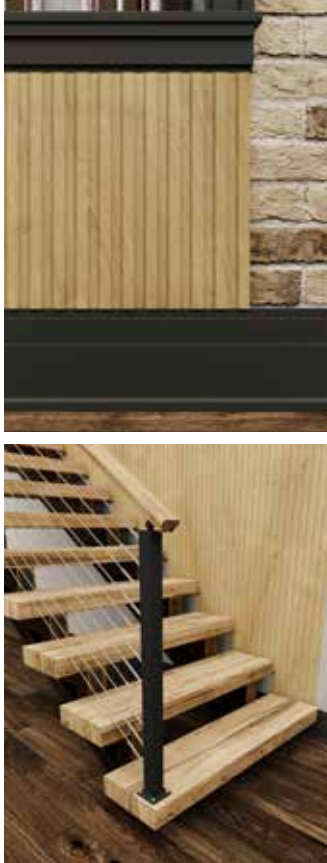

The mouldings listed may not be as shown in the image but are represented to achieve a similar style or look:

683 Casing | Architrave: **1X6 S4S +280** Back Band (x2) | Apron: **683** Casing
Base Buildup **E 714** Base + **414E** Base + **L 254** Shoe

Contemporary

Eclectic, Artistic, Avant-Garde. Full of life, culture, color, texture, unique and found objects, natural and man made materials...

At its core, the word "contemporary" means "of the moment". Sleek & thoughtful, contemporary design spaces often feature a mixture of both straight and elegantly curved lines, which can be seen as a slight nod to this style's art deco roots. Today, the look is defined by curved lines, and embraces minimalistic elements highlighting grays, beiges and shades of white. Although the contemporary trend changes with time, the basic cutting edge simplicity and idealism remains as unique as your vision.

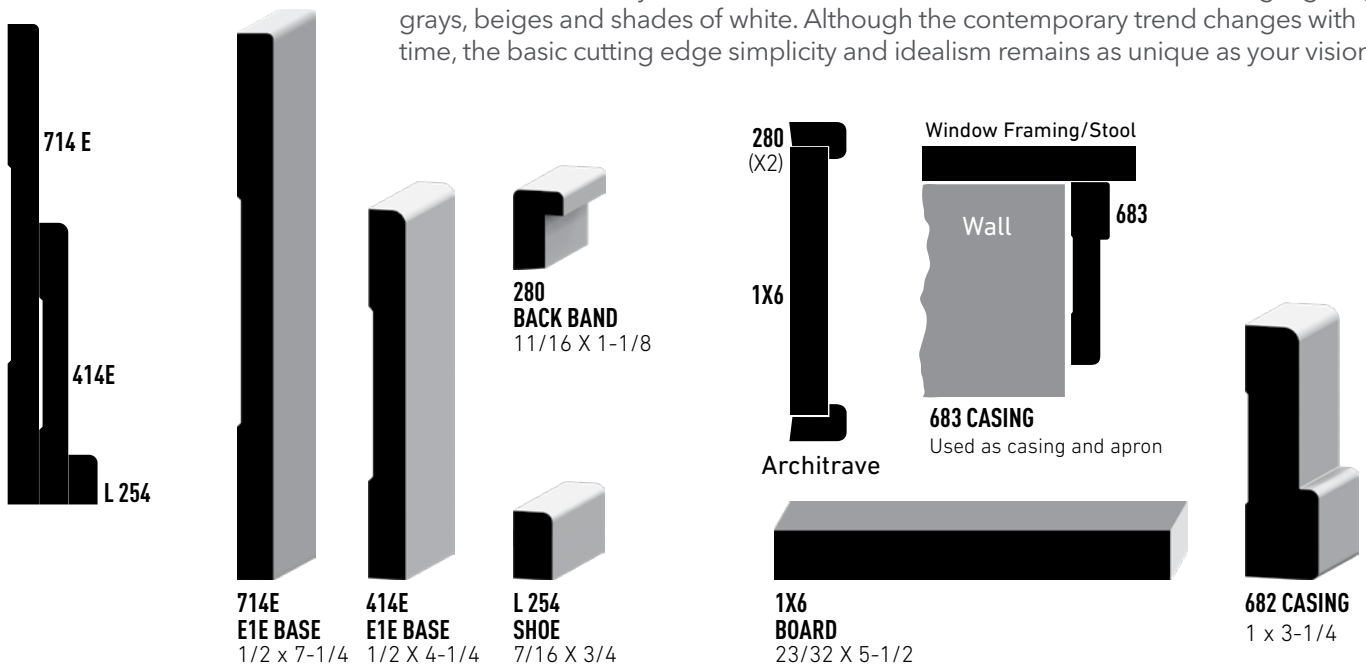

PROFILES SHOWN ARE NOT TO SCALE.



The mouldings listed may not be as shown in the image but are represented to achieve a similar style or look:

Crown Buildup: **L 340** Crown + **P 813** Base | **712** Shelf Edge
RB3 Casing | Base Buildup: **P 813** Base + **RB3** Casing

Victorian

Glamorous, Ornate, Art Deco, Baroque, Southern Plantation, Colonial Estate...

Victorian Mouldings hearken to the richness of old world artisan builders, craftsmen and clothiers that regarded every part of their work a piece of art. It is a style that can transform the bland into a bold statement of line and form. Ornate mouldings can be combined to restore a great Painted Lady or add a subtle flair and richness to add glamour to any room in your home.

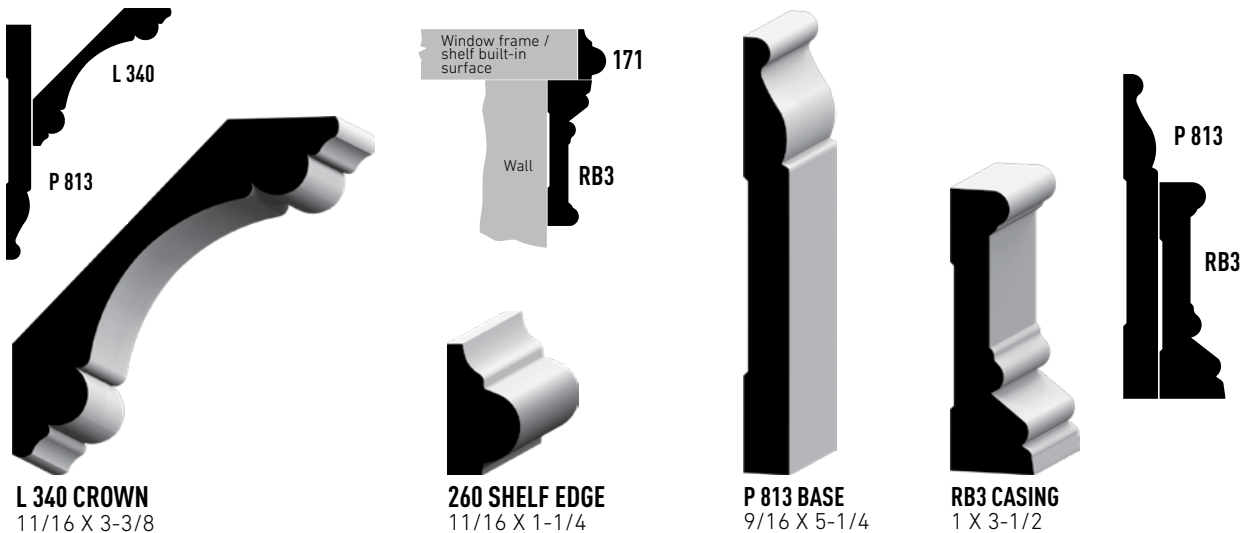

PROFILES SHOWN ARE NOT TO SCALE.



The mouldings listed may not be as shown in the image but are represented to achieve a similar style or look: **B G312** Casing w/**B G280** Back Band Casing | **B G512** Base | **B G100** Shoe | **SL16** Shiplap

Farmhouse

Farm and Cottage, Rustic and Finished, Handcrafted and Milled, Natural and Painted Woods, Sturdy Beams and Headers. Livable luxury — frontier simplicity... work... restore...

Classic, elegant and comfortable, the modern farmhouse decorating is rooted in rustic country charm peppered with warm minimalism. Striking just the right balance of pastoral and refined, modern farmhouse decor emphasizes comfort and casual living with contemporary sensibilities reflective of today's times. NOVO stocks a wide variety of hardwood and primed mouldings, boards, and wall panels from wainscoting, bead-board to shiplap. Combined with faux beams from Ornamental Mouldings to create warm and inviting spaces from cozy to dramatic and inviting for a family gathering.



SL16
NICKEL GAP
SHIPLAP
5/8 x 5-1/2



1X6 BOARD



280 BACK BAND
11/16 X 1-1/8



B G312 CASING
11/16 x 3-1/2



B G512 BASE
9/16 x 5-1/2



B G100 SHOE
5/8 x 1

PROFILES SHOWN ARE NOT TO SCALE.



Rustic Rough Sawn Shiplap

Prestained and ready to install, NOVO Rustic Shiplap will enhance any room with its warm country rugged charm. Rustic shiplap is real wood, thus each board will be slightly unique in grain pattern. Whether you use it to create an accent wall, a headboard, or to enhance an entire room, NOVO Shiplap will allow you to craft a custom designed and personally unique space.



**1 X 6
SHIPLAP**



**1 X 4
TRIM BOARD**

Rough Sawn Barnwood



CHAR

CHARCOAL
4 CHAR RRSSH 8'
 TRIM BOARD 1/2 X 3-1/2
6 CHAR RRSSH 8'
 SHIPLAP 1/2 X 5-3/8

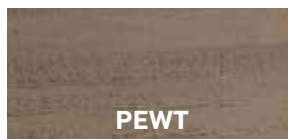

PEWT

PEWTER
4 PEWT RRSSH 8'
 TRIM BOARD 1/2 X 3-1/2
6 PEWT RRSSH 8'
 SHIPLAP 1/2 X 5-3/8

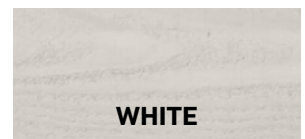

WHITE

WHITE
4 WHITE RRSSH 8'
 TRIM BOARD 1/2 X 3-1/2
6 WHITE RRSSH 8'
 SHIPLAP 1/2 X 5-3/8



The mouldings listed may not be as shown in the image but are represented to achieve a similar style or look:

SA612 Architrave | **L 433E** Base | **412** Casing w/**280** Back Band
L 414 E1E Base | **L 254** Shoe

Craftsman

Line and Structure, Handcrafted, Architectural, Artisan Craftsman, Modern-Farmhouse, Western Ranch...

Craftsman homes are full of endless detail and character, known for their natural materials, cozy interiors, and wide porches. Patterns and lines show the Arts & Crafts Architectural style through the use of natural woods combined with simple paint schemes. Wainscoting or beadboard detailing, and decorated ceilings with beams will help to give your home that warm feeling.



SA612
ARCHITRAVE
 1-1/2 X 6-1/2



L 433E E1E BASE
 1/2 X 3-1/4



412 E2E CASING
 19/32 X 3-1/2



280 BACK BAND
 11/16 X 1-1/8



L 414 E1E BASE
 9/16 X 4-1/4

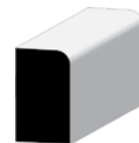

L 254
CRAFTSMAN SHOE
 7/16 X 3/4

PROFILES SHOWN ARE NOT TO SCALE.

Craftsman | Sleek, Modern, Simple

Crown

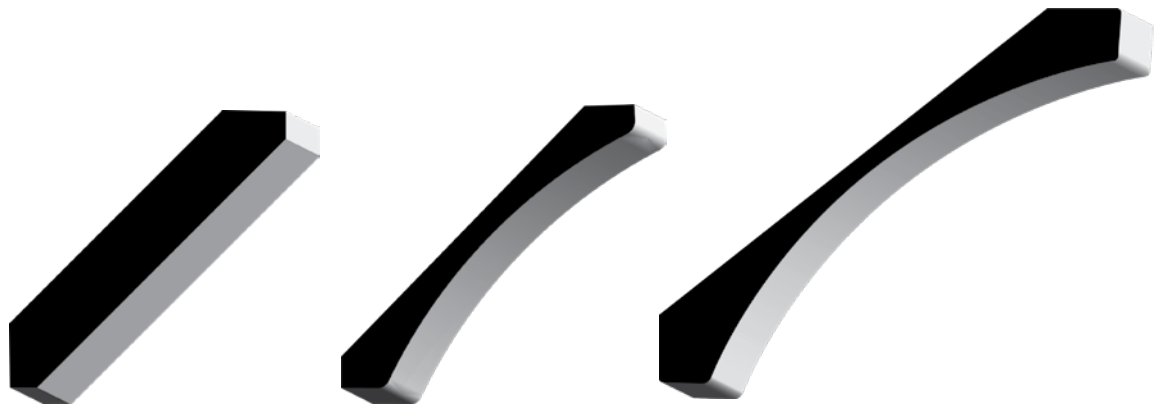

400
11/16 x 4-1/4
MDF 16'

E519
9/16 x 4-1/4
MDF 16'

505
1 x 7
MDF 16'

Base



L 433 E2E
7/16 x 3-1/4
PINE RL
3/8 x 3
OAK RL
POPLAR RL
1/2 x 3-1/4
MDF 16'



433E E1E
9/16 x 3-1/4
PRIMED 16'
L 433E E1E
1/2 x 3-1/4
MDF 8' | 12' | 16'
S L433 E1E
11/32 x 3-1/4
PRIMED 16'



435 E1E
7/16 x 4-1/4
OAK RL
POPLAR RL



L 414 E1E
9/16 x 4-1/4
PRIMED 16'
414E E1E
1/2 x 4-1/4
MDF 16'



L 430 E1E
7/16 x 4-1/4
PRIMED 16'

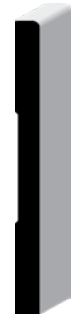

L 431 E1E
7/16 x 5-1/4
PRIMED 16'



L 514 E1E
7/16 x 5-1/4
POPLAR RL
9/16 x 5-1/4
PRIMED 16'



G 514
1/2 x 5-1/4
MDF 8' | 12' | 16'



8741
9/16 x 5-1/4
PRIMED 16'
1/2 x 5-1/4
MDF RL



512 E2E
1/2 x 5-1/2
MDF 8' | 12' | 16'



L 512 E2E
19/32 x 5-1/2
MDF 16'



512E E1E
1/2 x 5-1/2
MDF 16'



B G512
9/16 x 5-1/2
MDF 16'



B512
19/32 x 5-1/2
MDF 16'



B714
19/32 x 7-1/4
MDF 16'

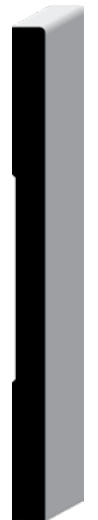

714E E1E
1/2 x 7-1/4
MDF 16'

L 512E E1E
19/32 x 5-1/2
MDF 16'

Lengths listed in RED are Extended lead time products - full bundle quantities only

Miscellaneous

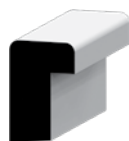

280 BACK BAND
 11/16 x 1-1/16
PRIMED RL
PINE 8'
 Fits up to 11/16 Profile

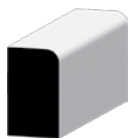

L 254 SHOE
 7/16 x 3/4
PRIMED 8' | 12' | 16'
POPLAR 2L
MDF 16'



B G100 SHOE
 5/8 x 1
PRIMED 16'



Casing



472 E2E
 9/16 x 2-1/2
PRIMED 16'
 19/32 x 2-1/2
MDF 8' | 16'



473 E2E
 9/16 x 2-1/4
PINE 7' | 8' | 1RL
PRIMED 14' | 1RL



L 473 E2E
 19/32 x 2-1/4
MDF 7'6" | 15'
 1/2 x 2-1/4
OAK 7' | 1RL
POPLAR 7' | 1RL



453 E2E
 11/16 x 2-1/4
PRIMED 7' | 7'6" | 16'



L 471 E2E
 19/32 x 2-3/4
MDF 15'



685
 11/16 x 2-3/4
MDF 16'
POPLAR 7'6" | 1RL



L 434
 11/16 x 3-1/4
POPLAR 7'6" | 1RL
OAK 8' | 1RL



682
 1 x 3-1/4
MDF 16'
 13/16 x 3-1/4
POPLAR 7'6" | 1RL



412 E2E
 19/32 x 3-1/2
MDF 8' | 16'



432 E2E
 9/16 x 3-1/2
PRIMED 16'



B G312
 11/16 x 3-1/2
MDF 16'



G 412
 19/32 x 3-1/2
MDF 16'



C312
 11/16 x 3-1/2
MDF 16'

E 412 E2E
 11/16 x 3-1/2
PRIMED 16'

Species listed in RED are Extended lead time products - full bundle quantities only

⚠ WARNING: Drilling, sawing, sanding or machining wood products can expose you to wood dust, a substance known to the State of California to cause cancer. Avoid inhaling wood dust or use a dust mask or other safeguards for personal protection. For more information go to www.P65Warnings.ca.gov/wood

Decorative Accessories

ORNAMENTAL

DECORATIVE MILLWORK

A NOVO Building Products Company

Expressing a style comes easier and has greater impact when your choices—from ceiling to floor—are all unified. For nearly 100 years, Ornamental Mouldings has been providing distinctive, high-quality millwork to make entire living spaces more beautiful. Our decorative accessory styles inspired by tradition and shaped by the latest trends complement one another for unmatched selection, all in one place.

Mantels and Floating Shelves

Whenever people enter a room, their eyes instantly take stock of the space. Reward their gaze with our Mantels and Floating Shelves, which marry function with details that convey a discerning sensibility.



Pattern	Product	H	D	L	Species
3 Ft. Mantel	3WM ORRMP	5	7	36	Rustic maple
4 Ft. Mantel	4WM ORRMP	5	7	48	
5 Ft. Mantel	5WM ORRMP	5	7	60	
6 Ft. Mantel	6WM ORRMP	5	7	72	



3 Ft. Mantel with insert	B 3WM 01 ORRMP	5	7	36	Rustic maple with aspen insert
4 Ft. Mantel with insert	B 4WM 01 ORRMP	5	7	48	
5 Ft. Mantel with insert	B 5WM 01 ORRMP	5	7	60	
6 Ft. Mantel with insert	B 6WM 01 ORRMP	5	7	72	



4 Ft. Mantel	CLAS 4 ORWHW	3 3/4	7 3/4	48	WHW
5 Ft. Mantel	CLAS 5 ORWHW	3 3/4	7 3/4	60	WHW
6 Ft. Mantel	CLAS 6 ORWHW	3 3/4	7 3/4	72	WHW



5 Ft. Mantel	CLAS 5 OROAK	3 3/4	7 3/4	60	Oak
6 Ft. Mantel	CLAS 6 OROAK	3 3/4	7 3/4	72	Oak

All measurements are in inches. Some items may be special order. Please call for details.

WARNING: Drilling, sawing, sanding or machining wood products can expose you to wood dust, a substance known to the State of California to cause cancer. Avoid inhaling wood dust or use a dust mask or other safeguards for personal protection. For more information go to www.P65Warnings.ca.gov/wood



Farmhouse | **OML14B, OML24C** | Mantel and Beams

Wood Beams

Practical elements like ceiling beams and wooden stairs are prime places for expressing your style. Our Wood Beams and Decorative Stair Parts give you the tools to achieve drama or convey delicate detailing.



Pattern	Product	H	W	L	Species
Prefinished gray beam	3 BEAM 8 ORPGY	3	5	96	Gray WHW
Prefinished gray beam	5 BEAM 8 ORPGY	5	5	96	Gray WHW

Rustic maple beam	3 BEAM 8 ORRMP	3	5	96	Rustic maple
Wood beam	5 BEAM 8 ORRMP	5	5	96	Rustic maple

3 inch metal beam-band/bracket	3 BRKT 5 METAL	3 ⁹ / ₆₄	1 1/2	6 ⁷ / ₁₆	Metal
5 inch metal beam-band/bracket	5 BRKT 5 METAL	5 ¹⁷ / ₆₄	1 1/2	6 ⁵ / ₁₆	Metal

All measurements are in inches. Some items may be special order. Please call for details.

WARNING: Drilling, sawing, sanding or machining wood products can expose you to wood dust, a substance known to the State of California to cause cancer. Avoid inhaling wood dust or use a dust mask or other safeguards for personal protection. For more information go to www.P65Warnings.ca.gov/wood



Decorative Boards

Create an impact that is more than meets the eye. Use our Decorative Boards to express your creativity with combinations that even at first glance speak volumes about your personal style.



Pattern	Product	W	T	L	Species
Decorative boards	A 1X2 8 MAPLE	1 1/2	7/16	96	Ambrosia Maple
	12X2 8 ORWOK	1 1/2	7/16	96	White Oak
Decorative boards eased edge two sides	12X2 8 ORPGY	1 1/2	7/16	96	Gray Stain
	12X2 8 ORPBK	1 1/2	7/16	96	Black Stain
Decorative boards	A 1X4 8 MAPLE	3 1/2	7/16	96	Ambrosia Maple
	12X4 8 ORWOK	3 1/2	7/16	96	White Oak
Decorative boards eased edge two sides	12X4 8 ORPGY	3 1/2	7/16	96	Gray Stain
	12X4 8 ORPBK	3 1/2	7/16	96	Black Stain
Decorative boards	A 1X6 8 MAPLE	5 1/2	7/16	96	Ambrosia Maple
	12X6 8 ORWOK	5 1/2	7/16	96	White Oak
Decorative boards eased edge two sides	12X6 8 ORPGY	5 1/2	7/16	96	Gray Stain
	12X6 8 ORPBK	5 1/2	7/16	96	Black Stain

All measurements are in inches. Some items may be special order. Please call for details.

Build-Ups

Combine moulding patterns to create a unique home style.

- Combine crowns, bases, casing, panel moulds, shoe or quarter rounds and more, to create detail, line and pattern.
- Use boards or square stock to build up depth.
- Combine square and eased edges to create richer detail.
- Use moulding with the same style families for a harmonious feel.
- Create completely unique build-ups to fit your own style.

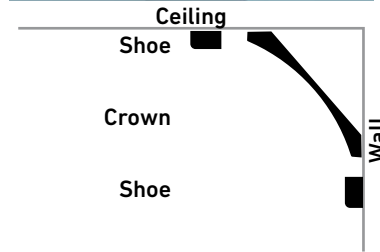
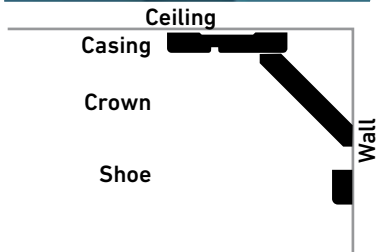
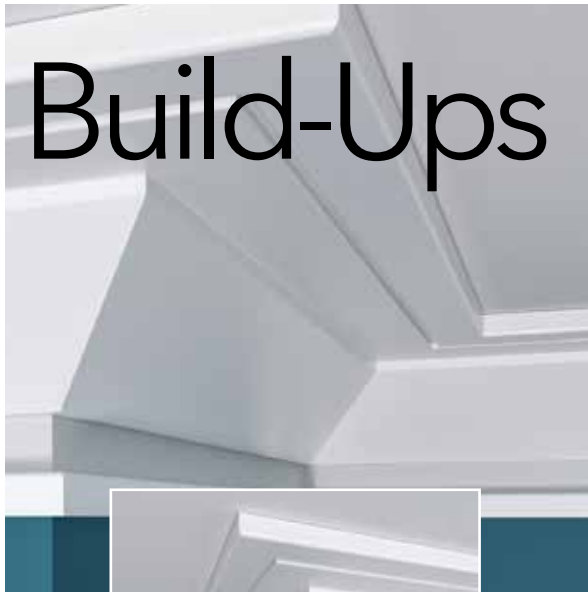

Crown

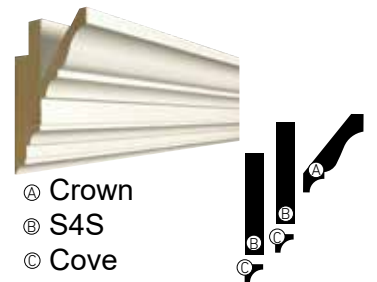

- Ⓐ Crown
- Ⓑ S4S
- Ⓒ Cove

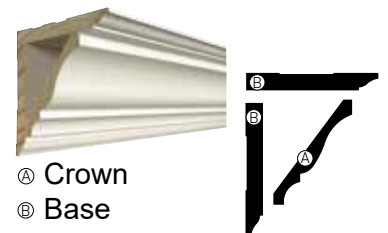

- Ⓐ Crown
- Ⓑ Base

Chair Rail



- Ⓐ Cove
- Ⓑ S4S
- Ⓒ Chair Rail

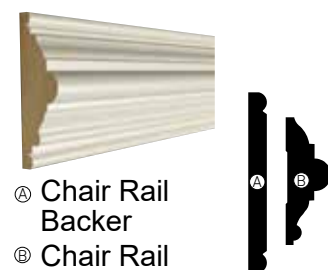

- Ⓐ Chair Rail Backer
- Ⓑ Chair Rail

Casing



- Ⓐ Stop
- Ⓑ Casing
- Ⓒ Cove



- Ⓐ Cove
- Ⓑ Casing
- Ⓒ Shoe

Base

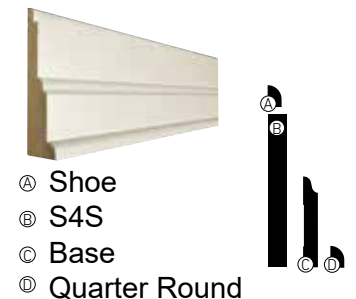

- Ⓐ Shoe
- Ⓑ S4S
- Ⓒ Base
- Ⓓ Quarter Round



- Ⓐ Cap
- Ⓑ S4S
- Ⓒ Quarter Round

Custom Manufacturing on DEMAND

by ORNAMENTAL
DECORATIVE MILLWORK



Quality custom and short run moulding orders with quick turn around!

Custom Manufacturing
on DEMAND

Specs

- 6-16 ft. lengths (random / clear) - Prime available up to 12 ft.
- Profile max = 11-3/4" width
- Minimum run = 3,000 ft. (less than charge can be applied)
- Unique capabilities: rope, dentil, emboss, carving

Material

- Poplar
- Solid Pine
- Red Oak
- White Oak
- Alder
- Cypress
- Soft Maple
- Hard Maple
- Ambrosia "Rustic" Maple
- Others available upon request and subject to availability

Timing

- 2-3 days for cost quote and estimated lead time
- Moulding sample or CAD drawing required
- Please contact your Sales Representative



Made in the USA

ORNAMENTAL

DECORATIVE MILLWORK

A NOVO Building Products Company

Visit NOVOBP.COM
to order NOVO
Building Products
online





HARDWOOD
PLYWOOD



THERMALLY
FUSED
LAMINATE



MEDIUM
DENSITY
FIBERBOARD



NOVO SHEET GOODS PROGRAM

PREMIUM SHEETS FOR HUNDREDS
OF INTERIOR APPLICATIONS

WIDE SELECTION OF SKU OFFERINGS

DELIVERED ON YOUR NEXT TRUCK ALONG
WITH YOUR MOULDING AND MILLWORK

NOVOBP.COM | 800.253.9000



Sheet Goods

Premium Hardwood - Plywood

NOVO SKU	SPECIE	THICKNESS (IMPERIAL)	THICKNESS (METRIC)	GRADE	SIZE
----------	--------	----------------------	--------------------	-------	------

BIRCH					
144 8 BCPLY	Domestic Natural WPF	1/4"	N/A	A4	48" x 96"
124 8 BCPLY	Domestic Natural WPF	1/2"	N/A	A1	48" x 96"
344 8 BCPLY	Domestic Natural WPF	3/4"	N/A	A1	48" x 96"
M 524 8 BCPLY	Cabinet Grade White	1/4"	5.2mm	C4	48" x 96"
M 124 8 BCPLY	Cabinet Grade White	1/2"	12mm	C2	48" x 96"
M 184 8 BCPLY	Cabinet Grade White	3/4"	18mm	C2	48" x 96"

OAK					
144 8 OKPLY	Domestic WPF	1/4"	N/A	A4	48" x 96"
124 8 OKPLY	Domestic WPF	1/2"	N/A	A1	48" x 96"
344 8 OKPLY	Domestic WPF	3/4"	N/A	A1	48" x 96"

MAPLE					
T 124 8 MPPLY	White UV 2 sides	1/2" UV2S	N/A	Premium	48" x 96"
T 344 8 MPPLY	White UV 2 sides	3/4" UV2S	N/A	Premium	48" x 96"
344 8 MPPLY	White	3/4"	N/A	Premium	48" x 96"

MERANTI (LAUAN)					
M 274 8 MRPLY	MERANTI	1/8"	2.7mm	OVL/BTR	48" x 96"
M 524 8 MRPLY	MERANTI	1/4"	5.2mm	OVL/BTR	48" x 96"

PINE					
144 8 PNPLY	PINE	1/4"	6.5mm	AC	48" x 96"
384 8 PNPLY	PINE	3/8"	9mm	AC	48" x 96"
124 8 PNPLY	PINE	1/2"	12mm	AC	48" x 96"
584 8 PNPLY	PINE	5/8"	15mm	AC	48" x 96"
344 8 PNPLY	PINE	3/4"	18mm	AC	48" x 96"
784 8 PNPLY	PINE	1"	25mm	AC	48" x 96"

🌿 ALL NOVO HARDWOOD PLYWOOD SHEETS MEET OR EXCEED HPVA SPECIFICATIONS



Sheet Goods Sheets & Shelving

NOVO SKU	SPECIE	THICKNESS (IMPERIAL)	THICKNESS (METRIC)	GRADE	SIZE
TFL (THERMALLY FUSED LAMINATE)					
344 8 TFPLY	GOOD 2 SIDE	3/4"	N/A	N/A	49" x 97"
3412 8 TFPLY	EDGE BANDED 1 SIDE	3/4"	N/A	N/A	12" (11-1/4) x 96"
3416 8 TFPLY	EDGE BANDED 1 SIDE	3/4"	N/A	N/A	16" (15-1/4) x 96"
3424 8 TFPLY	EDGE BANDED 1 SIDE	3/4"	N/A	N/A	24" (23-1/4) x 96"



Sheet Goods Medium Density Fiberboard

NOVO SKU	SPECIE	THICKNESS (IMPERIAL)	THICKNESS (METRIC)	GRADE	SIZE
FIBERBOARD					
M 554 8 MDPLY	Ultra-Lite MDF	1/4"	5.5mm	N/A	48" x 96"
M 94 8 MDPLY	Ultra-Lite MDF	3/8"	9mm	N/A	48" x 96"
M 124 8 MDPLY	Ultra-Lite MDF	1/2"	12mm	N/A	48" x 96"
M 154 8 MDPLY	Ultra-Lite MDF	5/8"	15mm	N/A	48" x 96"
M 184 8 MDPLY	Ultra-Lite MDF	3/4"	18mm	N/A	48" x 96"
M 254 8 MDPLY	Ultra-Lite MDF	1"	25mm	N/A	48" x 96"

ALL NOVO TFL AND MDF SHEETS ARE TSCA IV COMPLIANT and CARB APPROVED

Boards



HARDWOOD			
248 (1X2)	3/4 x 1-3/4	OAK	8' RL
		POPLAR	8' RL
246 (1X3)	3/4 x 2-3/4	OAK	8'
		POPLAR	RL
1X4	3/4 x 3-1/2	POPLAR, OAK	4' 6' 8' 10' 12' 14' 16'
		WHITE OAK	12' RL
		PRIMED FJ POPLAR	16'
		MAPLE	RL (Sold in unit quantities only)
1X6	3/4 x 5-1/2	POPLAR, OAK	4' 6' 8' 10' 12' 14' 16'
		WHITE OAK	12' RL
		PRIMED FJ POPLAR	16'
		MAPLE	RL (Sold in unit quantities only)
1X8	3/4 x 7-1/4	POPLAR, OAK	4' 6' 8' 10' 12' 14' 16'
		WHITE OAK	12' RL
		PRIMED FJ POPLAR	16'
		MAPLE	RL (Sold in unit quantities only)
1X10	3/4 x 9-1/4	POPLAR, OAK	8' 10' 12' 14' 16'
		WHITE OAK	RL
		MAPLE	RL (Sold in unit quantities only)
1X12	3/4 x 11-1/4	POPLAR	4' 6' 8' 10' 12' 14' 16'
		PRIMED FJ POPLAR	16' 18'
		OAK	10' 12' 14'
		OAK VENEER	16'

5/4X4	1-1/16 x 3-1/2	POPLAR	RL
5/4X6	1-1/16 x 5-1/2	POPLAR	RL
5/4X8	1-1/16 x 7-1/4	POPLAR	RL
5/4X10	1-1/16 x 9-1/4	POPLAR	RL
5/4X12	1-1/16 x 11-1/4	POPLAR	RL

SKIRTBOARDS			
1X12	3/4 x 11-1/4	OAK VENEER, POPLAR VENEER	18'
914E	1/2 x 9-1/4	MDF (S4S E1E BASE)	10' 18'
9713	(12mm) 1/2 x 9-1/4	MDF	10' 16' 18'
9623	(12mm) 1/2 x 9-1/4	MDF	10' 16'

PVC			
TRIM BOARD - EMBOSSED / SMOOTH			
7833	1X3	3/4 x 2-1/2	8'
7318	1X4	3/4 x 3-1/2	8' 12'
9767	1X4	3/4 x 3-1/2	18'
7311	1X6	3/4 x 5-1/2	8' 12'
9769	1X6	3/4 x 5-1/2	18'
9770	1X8	3/4 x 7-1/4	18'
9771	1X10	3/4 x 9-1/4	18'
9772	1X12	3/4 x 11-1/4	18'
9775	5/4X4	1 x 3-1/2	18'
9777	5/4X6	1 x 5-1/2	18'
9778	5/4X8	1 x 7-1/4	18'
9779	5/4X10	1 x 9-1/4	18'
9780	5/4X12	1 x 11-1/4	18'

Reversible Finish
Embossed / Smooth



SOFTWOOD MDF			
L 248 (1X2)	11/16 x 1-3/4	CLEAR PINE	RL
	11/16 x 1-3/4	PRIMED	16'
L 246 (1X3)	11/16 x 2-3/4	CLEAR PINE	RL
	11/16 x 2-3/4	PRIMED	16'
1X4	11/16 x 3-1/2	CLEAR PINE	4' 6' 8' 10' 12' 14' 16'
	23/32 x 3-1/2	PRIMED	8' 12'
	(18mm) 11/16 x 3-1/2	MDF	16'
1X4 E2E	11/16 x 3-1/2	PRIMED	12' 16'
1X6	11/16 x 5-1/2	CLEAR PINE	6' 8' 10' 12' 14' 16'
	23/32 x 5-1/2	PRIMED	8' 12'
	(18mm) 11/16 x 5-1/2	MDF	16'
1X6 E2E	11/16 x 5-1/2	PRIMED	12'
1X8	3/4 x 7-1/4	CLEAR PINE	8' 10' 12' 14' 16'
	23/32 x 7-1/4	PRIMED	8' 12'
	(18mm) 11/16 x 7-1/4	MDF	16'
1X10	3/4 x 9-1/4	CLEAR PINE	8' 10' 12' 14' 16'
	23/32 x 9-1/4	PRIMED	16'
	(18mm) 11/16 x 9-1/4	MDF	16'
1X12	3/4 x 11-1/4	CLEAR PINE	6' 8' 10' 12' 14' 16'
	23/32 x 11-1/4	PRIMED	8' 16'
	(18mm) 11/16 x 11-1/4	MDF	16'
5/4X4	1-1/16 x 3-1/2	PRIMED	12' 16'
	(25mm) 1 x 3-1/2	MDF	16'
5/4X6	1-1/16 x 5-1/2	PRIMED	12' 16'
	(25mm) 1 x 5-1/2	MDF	16'
5/4X8	1-1/16 x 7-1/4	PRIMED	16'
	(25mm) 1 x 7-1/4	MDF	16'
5/4X10	1-1/16 x 9-1/4	PRIMED	16'
5/4X12	1-1/16 x 11-1/4	PRIMED	16'
	(25mm) 1 x 11-1/4	MDF	16'

EASED EDGE MDF BOARDS			
E1X2	(17mm) 11/16 x 1-1/2		8' 10'
E1X3	(17mm) 11/16 x 2-1/2		8'
E1X4	(17mm) 11/16 x 3-1/2		8' 10' 12' 16' (18mm thick)
E1X6	(17mm) 11/16 x 5-1/2		8' 12' 16' (18mm thick)
E1X8	(17mm) 11/16 x 7-1/4		8' 16' (18mm thick)

Lengths listed in RED are Extended lead time products - full bundle quantities only



Species Definitions

DFIR	Doug Fir
DOUBLE PRIMED (FJDP)	Finger Joint Primed Pine (Double Pass)
MAPLE	Maple
MAPLS	Maple Boards
MDF (FBDPM)	Primed MDF Fiber Board
OAK (OAKSL)	Red Oak
OAKBD	Oak Board
PINE	Pine
PINEV	Pine Veneer
SPINE	Southern Yellow Pine
PRIMED (FJPM)	Finger Joint Primed Pine
POPLAR (POPLR)	Poplar
POPBD	Poplar Board
POPFP	Poplar Finger Joint Primed
VNLVL	Vinyl Wrapped Wood
WHITE	PVC Vinyl

Finger-Jointed Moulding from our quality suppliers is precision milled using advanced technology in a wide selection of profiles. The advanced manufacturing methods and the woods superior moulding characteristics result in long lengths and very few defects.

- All products should be inspected for manufacturing defects prior to painting or installing.
- Please store horizontally and off the floor, and let acclimate 72 hours prior to installation.
- Install with 15-18ga pin nails with proper air pressure to counter sink fastener 1/16".
- Use light weight spackle and paintable latex caulk when filling and sand with 80-120 grit paper.
- Finish with a good quality latex paint applied following the manufacturer's specifications.
- Manufacturing guidelines encompass tolerances of up to 1/32 inch.

MDF from our quality suppliers is light-weight and manufactured using eco-friendly standards. The superior workability of our MDF mouldings offers an ease of cutting, mitering and finishing, making it excellent for any size job. The combination of light-weight substrate, consistent easy to paint surface and long lengths, result in superior workmanship and a streamlined final finishing process.

- All products should be inspected for manufacturing defects prior to painting or installing.
- Please store horizontally and off the floor, and let acclimate 72 hours prior to installation.
- Install with 15-18ga pin nails with air pressure set 90-110psi to counter sink fastener 1/16".
- Use light weight spackle and paintable latex caulk when filling and sand with 80 grit paper.
- Finish with a good quality latex paint applied following the manufacturer's specifications.

Casing



316
 11/16 x 2-1/4
 PINE 7' | 10' | 14'
 PRIMED 7' | 10' | 14'
 5/8 x 2-1/4
 OAK 7' | RL



321
 11/16 x 2-1/4
 PINE 7' | RL

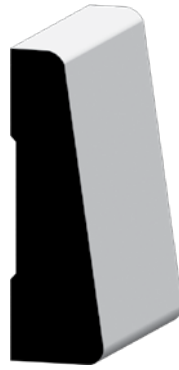

324
 11/16 x 2-1/4
 PINE 7' | RL

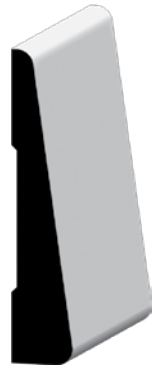

L 324
 1/2 x 2-1/4
 OAK 7' | RL



327
 11/16 x 2-1/4
 PINE 7' | 10' | 14' | RL
 PRIMED 7' | 14'



356C
 11/16 x 2-1/4
 PRIMED 15'



L 356
 1/2 x 2-1/4
 OAK 7' | 10' | RL
L 356 (14mm)
 9/16 x 2-1/4
 MDF 7' | 10'



356
 11/16 x 2-1/4
 PINE 7' | 10' | 14' | RL
 PRIMED 7' | 14'
 19/32 x 2-1/4
 MDF 14'
 5/8 x 2-1/4
 OAK 7' | 10' | RL
 POPLAR 7' | RL



366
 11/16 x 2-1/4
 PINE 7' | 10' | 14'
 PRIMED 7' | 7'2" | 10' | 14'



L 366 (14mm)
 9/16 x 2-1/4
 OAK 7' | 10'



366A
 19/32 x 2-1/4
 MDF 7' | 14'



376
 11/16 x 2-1/4
 MDF 16'

Lengths listed in RED are Extended lead time products - full bundle quantities only



473 EZE
 9/16 x 2-1/4
 PINE 7' | 8' | RL
 PRIMED 14' | RL



L 473 EZE
 7/16 x 2-1/4
 PRIMED 16'
 19/32 x 2-1/4
 MDF 7'6" | 15'
 1/2 x 2-1/4
 OAK 7' | RL
 POPLAR 7' | RL



453 EZE
 11/16 x 2-1/4
 PRIMED 7' | 7'6" | 16'



452 EZE
 11/16 x 2-1/2
 PRIMED 16'



472 EZE
 9/16 x 2-1/2
 PRIMED 16'
 19/32 x 2-1/2
 MDF 8' | 16'



351
 11/16 x 2-1/2
 PINE 14'
 PRIMED 7' | 14'



361
 11/16 x 2-1/2
 PINE RL
 PRIMED 14'
 19/32 x 2-1/2
 MDF 14'
 9/16 x 2-1/2
 OAK RL



795
 11/16 x 2-1/2
 MDF 14'



4532
 11/16 x 2-1/2
 MDF 15'



474
 11/16 x 2-3/4
 PRIMED 15'

Lengths listed in RED are Extended lead time products - full bundle quantities only

⚠ WARNING: Drilling, sawing, sanding or machining wood products can expose you to wood dust, a substance known to the State of California to cause cancer. Avoid inhaling wood dust or use a dust mask or other safeguards for personal protection. For more information go to www.P65Warnings.ca.gov/wood

Casing



685
 11/16 x 2-3/4
 MDF 16'
 POPLAR 7'6" | RL



L 471 E2E
 19/32 x 2-3/4
 MDF 15'



P 380
 11/16 x 2-3/4
 PRIMED 7'4" | 7'6" | 15'
 MDF 16'
 POPLAR RL



4520
 11/16 x 2-3/4
 MDF 15'



2496
 11/16 x 3
 PRIMED 16'



312
 19/32 x 3
 MDF 8' | 16'



411
 11/16 x 3
 MDF 16'



L 444
 11/16 x 3-1/4
 PINE 16' | RL
 PRIMED 7'6" | 15'
 POPLAR 7'6" | RL
 19/32 x 3-1/4
 MDF 16'
 3/4 x 3-1/4
 OAK 8' | RL



PT3
 1 x 3-1/4
 MDF 8' | 12' | 16'

Lengths listed in RED are Extended lead time products - full bundle quantities only



445
11/16 x 3-1/4
PRIMED 15'



445A
11/16 x 3-1/4
MDF 8' | 16'



40
9/16 x 3-1/4
OAK RL



L 366
11/16 x 3-1/4
PRIMED 7' | 15'



L 434
11/16 x 3-1/4
POPLAR 7'6" IRL
OAK 8' IRL



683
11/16 x 3-1/4
PRIMED 16'
MDF 16'



682
1 x 3-1/4
MDF 16'
13/16 x 3-1/4
POPLAR 7'6" IRL



L CC14
3/4 x 3-1/4
MDF 16'

Lengths listed in RED are Extended lead time products - full bundle quantities only

⚠ WARNING: Drilling, sawing, sanding or machining wood products can expose you to wood dust, a substance known to the State of California to cause cancer. Avoid inhaling wood dust or use a dust mask or other safeguards for personal protection. For more information go to www.P65Warnings.ca.gov/wood

Casing



L 338
9/16 x 3-3/8
MDF 8'



L 361
11/16 x 3-1/2
PINE RL
PRIMED 7'4" | 15'



L 361C
11/16 x 3-1/2
PRIMED 16'



444
11/16 x 3-1/2
PINE 8'
PRIMED 8' | 12' | 16'



444A
11/16 x 3-1/2
MDF 16'



374
11/16 x 3-1/2
PRIMED 16'
MDF 16'
3/4 x 3-1/2
OAK RL



P 450
11/16 x 3-1/2
PRIMED 7'4" | 10' | 16'
MDF 16'



535
11/16 x 3-1/2
MDF 16'



EDC97
1 x 3-1/2
MDF 16'

Lengths listed in RED are Extended lead time products - full bundle quantities only



C PT11
3/4 x 3-1/2
MDF 16'



446
11/16 x 3-1/2
MDF 16'



B G312
11/16 x 3-1/2
MDF 16'



G 412
19/32 x 3-1/2
MDF 16'



412 E2E
19/32 x 3-1/2
MDF 8' | 16'

E412 E2E
11/16 x 3-1/2
PRIMED 16'

432 E2E
9/16 x 3-1/2
PRIMED 16'



RB3
1 x 3-1/2
MDF 16'



S RB3
1-1/16 x 3-1/2
PRIMED 16'



C312
11/16 x 3-1/2
MDF 16'



465
11/16 x 4-1/4
MDF 16'

Lengths listed in RED are Extended lead time products - full bundle quantities only

⚠️WARNING: Drilling, sawing, sanding or machining wood products can expose you to wood dust, a substance known to the State of California to cause cancer. Avoid inhaling wood dust or use a dust mask or other safeguards for personal protection. For more information go to www.P65Warnings.ca.gov/wood

Casing Corner Blocks



Pictured: **734** Bullseye Rosette Corner Casing Block | Also Shown: **1888** Crown Corners (see page:53) & **1403** Plint Base Block (see page:35).
All blocks shown primed and painted.

Moulding Blocks:

Casing Corner Blocks, Crown Blocks and Plinth Blocks add decorative detail and greatly simplify moulding installation without the use of mitering corners. Plinth Blocks offer transitions between varying bases and casing profiles while adding depth and structure to the cased opening. Using Moulding Blocks is often a perfect solution for DIYers.



BULLSEYE ROSETTE

642
5/8 x 2-1/2 **PINE**
WHITE WOOD

734
27/32 x 3-1/2 **WHITE WOOD**
13/16 x 3-1/2 **OAK**

740
27/32 x 4-1/2 **WHITE WOOD**



FLORAL ROSETTE - BEVELED

871
1-1/16 x 3-1/2 **WHITE WOOD**

915
27/32 x 2-1/2 **PINE**
WHITE WOOD
OAK



BULLSEYE ROSETTE - BEVELED

1400
7/8 x 2-3/4 **PRIMED**
OAK

1402
7/8 x 3-3/4 **PRIMED**
OAK



STAR ROSETTE

1200
1-1/16 x 3-1/2 **WHITE WOOD**



BULLSEYE ROSETTE - BEVELED

3
7/8 x 3 **MDF**

334
7/8 x 3-3/4 **MDF**

438
1 x 4-3/8 **MDF**



BULLSEYE ROSETTE - BEVELED

P 358 35
1 x 3-5/8 **POPLAR**

Lengths listed in RED are Extended lead time products - full bundle quantities only

Architraves



Pictured: **SL16** Shiplap | **5030** Architrave | **E412 E2E** Casing



5010 ARCHITRAVE
1-3/16 x 4-1/4
MDF **8'** | 16'



5021 ARCHITRAVE
1-1/8 x 5-5/16
MDF 16'



5030 ARCHITRAVE
1-3/16 x 6-1/4
MDF 16'

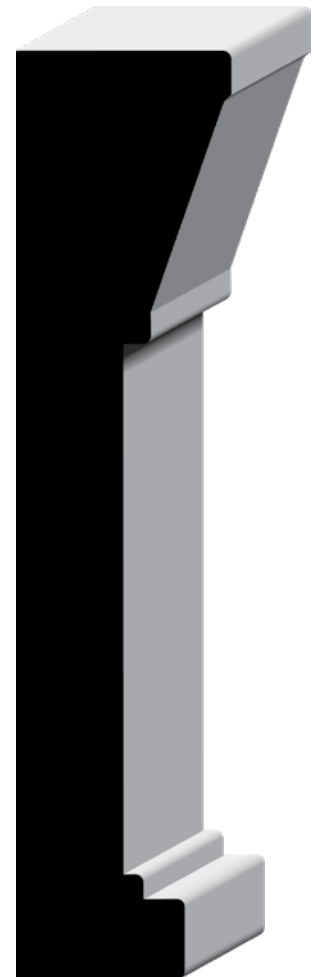

SA612 ARCHITRAVE
1-1/2 x 6-1/2
MDF 16'

Species listed in RED are Extended lead time products - full bundle quantities only

⚠️WARNING: Drilling, sawing, sanding or machining wood products can expose you to wood dust, a substance known to the State of California to cause cancer. Avoid inhaling wood dust or use a dust mask or other safeguards for personal protection. For more information go to www.P65Warnings.ca.gov/wood

Stops | Mullions



857
3/8 x 1-1/4
PINE 7'



L 887 E2E
3/8 x 1-1/4
PINE 7' | RL
OAK 7' | RL
POPLAR 7' | RL
PRIMED 7'
MDF 7' | 8' | 16'



887 E1E
3/8 x 1-1/4
PRIMED 7'



947
3/8 x 1-1/4
PINE 7' | 10' | RL
OAK 7'
POPLAR 7' | RL
PRIMED 7' | 17'
DOUBLE PRIMED 7'



846
7/16 x 1-3/8
PINE RL



856
3/8 x 1-3/8
PINE RL

N 947

3/8 x 1-1/4
MDF 7'



876 E1E
7/16 x 1-3/8
PINE 7' | 10'
POPLAR 7' | RL
PRIMED 8'2" | 10'



B 876 E2E
1/2 x 1-3/8
MDF 7'2" | 8'2"



936
7/16 x 1-3/8
PINE 7' | RL
PRIMED 7'
OAK 7' | RL
POPLAR 7'

B 936

1/2 x 1-3/8
MDF 7'2" | 8'2"



N 946
3/8 x 1-3/8
PINE 7'



935
7/16 x 1-5/8
PINE RL



1305 T-ASTRAGAL
1-1/4 x 2
PINE 8'
PRIMED 7'



L 973
3/8 x 1-5/8
PINE 8'



L 983
3/8 x 1-5/8
PINE 8'



972 E2E
3/8 x 2
PINE RL

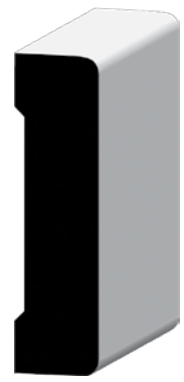

L 473 E2E
7/16 x 2-1/4
PRIMED 16'

Lengths listed in RED are Extended lead time products - full bundle quantities only

Back Bands | Brick | Stool

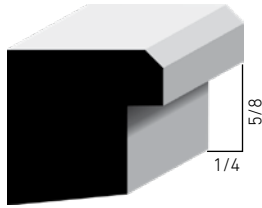

**B G200 BEVEL NOSE
BACK BAND**
1-1/16 x 1-1/16
PRIMED 16'

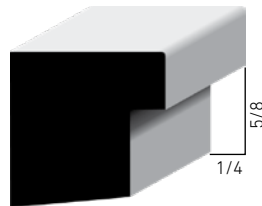

B G250 BACK BAND
1-1/16 x 1-1/16
PRIMED 16'

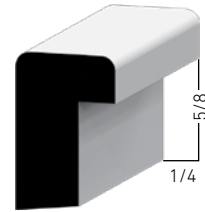

280 BACK BAND
11/16 x 1-1/16
PRIMED RL
PINE 8'
Fits up to 11/16 Profile

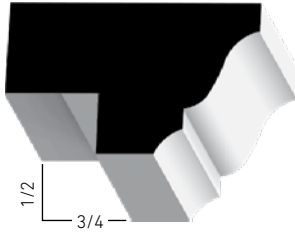

H 282 BACK BAND
2 x 1-1/4
POPLAR RL

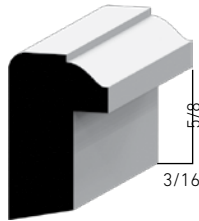

281 BACK BAND
11/16 x 1-1/8
PINE RL
Fits up to 11/16 Profile

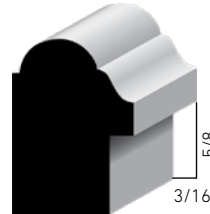

227 BACK BAND
1-1/16 x 1-17/32
PRIMED 16'

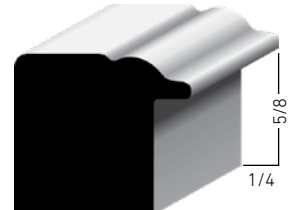

279 BACK BAND
1-1/16 x 1-1/8
PRIMED 16'



4 1021
11/16 x 4-1/2
PRIMED 16'



**E 1035 EXTENDED
HALF ROUND**
1/2 x 1-3/8
MDF 8'
POPLAR 8' IRL



1021 STOOL
11/16 x 5-1/4
PINE RL
MDF 16'
PRIMED 16'



1153 STOOL
11/16 x 3-1/4
PINE RL



7 1021 STOOL
11/16 x 7-1/4
PRIMED 16'



S 200 STOOL
1-1/4 x 1-3/4
PRIMED 16'

Species listed in RED are Extended lead time products - full bundle quantities only

WARNING: Drilling, sawing, sanding or machining wood products can expose you to wood dust, a substance known to the State of California to cause cancer. Avoid inhaling wood dust or use a dust mask or other safeguards for personal protection. For more information go to www.P65Warnings.ca.gov/wood

Door Jambs

NOVO SKU	LENGTH	DESCRIPTION
FINGER JOINT PRIMED PINE		
458 68 FJPM	6'8"	11/16 X 4-5/8 JAMB PAIR 81BD
458 80 FJPM	8'	11/16 X 4-5/8 JAMB PAIR 97BD
478 68 FJPM	6'8"	11/16 X 4-7/8 FLAT JAMB PAIR 81BD
478 70 FJPM	7'	11/16 X 4-7/8 FLAT JAMB PAIR 85BD
478 80 FJPM	8'	11/16 X 4-7/8 FLAT JAMB PAIR 97BD
5 70 FJPM	7'	11/16 X 5 JAMB PAIR 85BD
5 80 FJPM	8'	11/16 X 5 JAMB PAIR 97BD
514 68 FJPM	6'8"	11/16 X 5-1/4 FLAT JAMB PAIR 81BD
678 68 FJPM	6'8"	11/16 X 6-7/8 FLAT JAMB PAIR 81BD
678 80 FJPM	8'	11/16 X 6-7/8 FLAT JAMB PAIR 97BD
4916 68 FJPM	6'8"	11/16 X 4-9/16 JAMB PAIR 81BD
2 4916 68 SPTFP	6'8"	4-9/16 X 2-3/4 X 2-1/2 SPLIT JAMB PAIR
3 4916 68 SPTFP	6'8"	11/16 X 4-9/16 FLT JAMB PAIR 81-3/8BD
4916 70 FJPM	7'	11/16 X 4-9/16 JAMB PAIR 85BD
4916 80 FJPM	8'	11/16 X 4-9/16 JAMB PAIR 85BD
4916 R7 FJPM	17'	11/16 X 4-9/16 JAMB LINEAL
6916 70 FJPM	6'8"	11/16 X 6-9/16 JAMB PAIR 85BD
6916 70 FJPM	7'	11/16 X 6-9/16 JAMB PAIR 85BD
6916 80 FJPM	8'	11/16 X 6-9/16 JAMB PAIR 97BD
714 80 FJPM	8'	11/16 X 7-1/4 JAMB PAIR 97BD
PINE		
2 4916 68 SPLTS	6'8"	4-9/16 X 2-3/4 FM X 2-1/2 M SPLIT JAMB PAIR
PINE VENEER W/FJ CORE		
X 4916 68 PINEV	6'8"	11/16 X 4-9/16 JAMB SIDE
478 68 PINEV	6'8"	11/16 X 4-7/8 JAMB PAIR 81BD
514 68 PINEV	6'8"	11/16 X 5-1/4 JAMB PAIR
6916 68 PINEV	6'8"	11/16 X 6-9/16 JAMB PAIR 81BD
FJ PRIMED POPLAR		
4916 68 POPFP	6'8"	11/16 X 4-9/16 JAMB PAIR 81BD
MDF		
458 68 MDF	6'8"	11/16 X 4-5/8 JAMB PAIR 81BD
4131 68 FBDPM	6'8"	17MM(11/16)X 4-13/16 FLAT JAMB PAIR 81BD
3 4131 68 FBDPM	6'8"	17MM(11/16)X 4-13/16 FLAT JAMB PAIR 81-3/8BD
3 4916 68 FBDPM	6'8"	PR17MM(11/16) X 4-9/16 FLT JAMB 81-3/8BD
X 4916 68 FBDPM	6'8"	11/16 X 4-9/16 JAMB SIDE 81BD
X 6916 68 FBDPM	6'8"	11/16 X 6-9/16 JAMB SIDE 81BD
OAK VENEER		
V 4916 68 OAKOV	6'8"	11/16 X 4-9/16 JAMB PAIR 81BD
W 4916 68 OAKVN	6'8"	11/16 X 4-9/16 JAMB PAIR 81BD

Lengths listed in RED are Extended lead time products - full bundle quantities only

Base Block



PLINTH BLOCK - BEVELED
1401 PB
 7/8 x 2-3/4 x 4-1/2 **PRIMED OAK**

1403 PB
 7/8 x 3-3/4 x 6 **PRIMED OAK**

917 PB
 1-1/8 x 3-1/2 x 6-1/2 **PINE OAK**



PLINTH BLOCK - MOULDED
887 PB
 27/32 x 2-1/2 x 5-3/4 **WHITE WOOD**

742 PB
 1-1/8 x 3-1/2 x 6-1/2 **PINE OAK WHITE WOOD**

334 PB
 1 x 3-3/4 x 9 **MDF**

438 PB
 1 x 4-3/8 x 9 **MDF**

743 PB
 1-1/16 x 4-1/2 x 8 **WHITE WOOD**



BASE BLOCK - OUTSIDE CORNER
892
 1-1/8 x 6-3/4 **WHITE WOOD**

8920
 1-1/8 x 6-3/4 **PINE**

9 OS
 1-1/4 x 9 **MDF**

BASE BLOCK - INSIDE CORNER
895
 7/8 x 6-3/4 **WHITE WOOD**

8951
 7/8 x 6-3/4 **PINE**

9 IS
 7/8 x 9 **MDF**



BASE BLOCK - OUTSIDE CORNER
1892
 1-1/8 x 6-1/2 **PRIMED OAK**

BASE BLOCK - INSIDE CORNER
1895
 1-1/8 x 6-1/2 **PRIMED OAK**

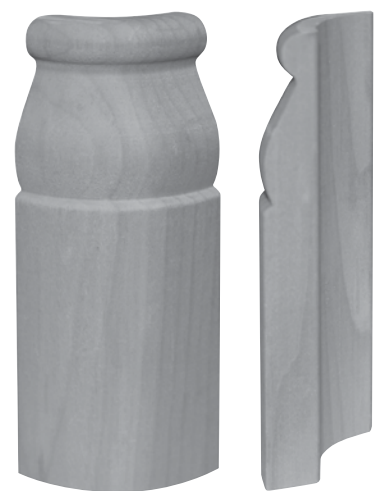

RADIUS BASE BLOCK
P 808
 9/16 x 4-1/4 x 3/4 RAD **POPLAR**

P 813
 9/16 x 5-1/4 x 3/4 RAD **POPLAR**

Base Cap



166 BASE CAP
 11/16 x 1-1/4
PINE RL
PRIMED 16'



163 BASE CAP
 11/16 x 1-3/8
MDF 16'
POPLAR RL

L 163 BASE CAP
 5/8 x 1-3/8
PRIMED 8' | 12'



8740 BASE CAP
 5/8 x 1-3/4
PRIMED 16'

Species listed in RED are Extended lead time products - full bundle quantities only

WARNING: Drilling, sawing, sanding or machining wood products can expose you to wood dust, a substance known to the State of California to cause cancer. Avoid inhaling wood dust or use a dust mask or other safeguards for personal protection. For more information go to www.P65Warnings.ca.gov/wood

Base



L 634
 7/16 x 3
 PINE **8' | 12' | RL**
 PRIMED **8' | 12' | 16'**
 3/8 x 2-3/4
 OAK **8' | 12' | RL**



L 724
 7/16 x 3
 PINE **8' | 12' | 16'**
 PRIMED **8' | 12' | 16'**
 3/8 x 2-3/4
 OAK **8' | 12'**



714
 9/16 x 3
 PINE RL



L 635
 3/8 x 3
 OAK RL



L 433 E2E
 7/16 x 3-1/4
 PINE RL
 3/8 x 3
 OAK RL
 POPLAR RL
 1/2 x 3-1/4
 MDF **16'**



433E E1E
 9/16 x 3-1/4
 PRIMED **16'**
L 433E E1E
 1/2 x 3-1/4
 MDF **8' | 12' | 16'**
S L433 E1E
 11/32 x 3-1/4
 PRIMED **16'**



623
 9/16 x 3-1/4
 PINE **8' | 12' | 16' | RL**
 PRIMED **8' | 10' | 12' | 16'**
 1/2 x 3-1/4
 MDF **8' | 12' | 16'**



L 633
 7/16 x 3-1/4
 PINE RL
 PRIMED **16'**

Lengths listed in RED are Extended lead time products - full bundle quantities only



H 633
 1/2 x 3-1/4
 OAK RL
 POPLAR RL



663
 9/16 x 3-1/4
 PINE RL
 PRIMED 16'
 1/2 x 3-1/4
 MDF 16'



P 805
 9/16 x 3-1/4
 PRIMED 8' | 12'
 PRIMED 16'



B 366
 9/16 x 3-1/4
 MDF 16'



713
 9/16 x 3-1/4
 PINE 8' | 16'
 PRIMED 8' | 12' | 16'



L 723
 7/16 x 3-1/4
 PINE RL



620
 9/16 x 4-1/4
 PINE 8' | 16' | RL
 PRIMED 8' | 12' | 16'
 1/2 x 4-1/4
 MDF 8' | 12' | 16'



L 620
 1/2 x 4-1/4
 OAK 2L
 POPLAR RL

Species listed in RED are Extended lead time products - full bundle quantities only

⚠️WARNING: Drilling, sawing, sanding or machining wood products can expose you to wood dust, a substance known to the State of California to cause cancer. Avoid inhaling wood dust or use a dust mask or other safeguards for personal protection. For more information go to www.P65Warnings.ca.gov/wood

Base



L 414 E1E
 $9/16 \times 4-1/4$
PRIMED 16'



414E E1E
 $1/2 \times 4-1/4$
MDF 16'



L 430 E1E
 $7/16 \times 4-1/4$
PRIMED 16'



435 E1E
 $7/16 \times 4-1/4$
OAK RL
POPLAR RL



410
 $19/32 \times 4-1/4$
MDF 16'



BC14
 $11/16 \times 4-1/4$
MDF 16'



P 808
 $9/16 \times 4-1/4$
PINE RL
PRIMED 8' | 12' | 16'
 $1/2 \times 4-1/4$
MDF 16'
OAK RL
POPLAR RL



B PT11
 $9/16 \times 4-1/2$
MDF 16'

Lengths listed in RED are Extended lead time products - full bundle quantities only



545
19/32 x 5
MDF 16'



163E
19/32 x 5-1/4
MDF 16'



763
19/32 x 5-1/4
MDF 16'



L 431 E1E
7/16 x 5-1/4
PRIMED 16'

L 163E
1/2 x 5-1/4
MDF 8' | 12'
9/16 x 5-1/4
PRIMED 8' | 12' | 16'



L 514 E1E
7/16 x 5-1/4
POPLAR RL
9/16 x 5-1/4
PRIMED 16'

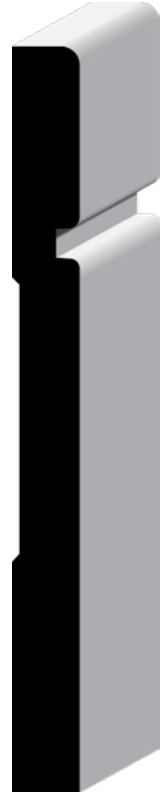

G 514
1/2 x 5-1/4
MDF 8' | 12' | 16'

Species listed in RED are Extended lead time products - full bundle quantities only

⚠ WARNING: Drilling, sawing, sanding or machining wood products can expose you to wood dust, a substance known to the State of California to cause cancer. Avoid inhaling wood dust or use a dust mask or other safeguards for personal protection. For more information go to www.P65Warnings.ca.gov/wood

Base



B 312
19/32 x 5-1/4
MDF 16'



L 618
1/2 x 5-1/4
MDF 16'

618
9/16 x 5-1/4
PINE RL
PRIMED 8' | 12' | 16'



P 813
9/16 x 5-1/4
PINE RL
PRIMED 16'
1/2 x 5-1/4
MDF 16'
POPLAR RL

L P813
19/32 x 5-1/4
MDF 16'



674
9/16 x 5-1/4
PRIMED 16'
1/2 x 5-1/4
OAK RL



658
9/16 x 5-1/4
PRIMED 16'



512 E2E
1/2 x 5-1/2
MDF 8' | 12' | 16'

Lengths listed in RED are Extended lead time products - full bundle quantities only



B G512
9/16 x 5-1/2
MDF 16'



512E E1E
1/2 x 5-1/2
MDF 16'
L 512E E1E
19/32 x 5-1/2
MDF 16'



L512 E2E
19/32 x 5-1/2
MDF 16'



B512
19/32 x 5-1/2
MDF 16'

8740 BASE CAP
5/8 x 1-3/4
PRIMED 16'



8741
9/16 x 5-1/4
PRIMED 16'
1/2 x 5-1/4
MDF RL

Species listed in RED are Extended lead time products - full bundle quantities only

⚠️WARNING: Drilling, sawing, sanding or machining wood products can expose you to wood dust, a substance known to the State of California to cause cancer. Avoid inhaling wood dust or use a dust mask or other safeguards for personal protection. For more information go to www.P65Warnings.ca.gov/wood

Base



8263
19/32 x 6-1/2
MDF 16'



263
11/16 x 7
PRIMED 16'



L P815
19/32 x 7-1/4
MDF 16'

P 815
9/16 x 7-1/4
PRIMED 16'



765
19/32 x 7-1/4
MDF 16'



7163
19/32 x 7-1/4
MDF 16'



207
19/32 x 7-1/4
MDF 16'



714E1E
1/2 x 7-1/4
MDF 16'



B714
19/32 x 7-1/4
MDF 16'



G714
1/2 x 7-1/4
MDF 16'

Species listed in RED are Extended lead time products - full bundle quantities only

⚠️WARNING: Drilling, sawing, sanding or machining wood products can expose you to wood dust, a substance known to the State of California to cause cancer. Avoid inhaling wood dust or use a dust mask or other safeguards for personal protection. For more information go to www.P65Warnings.ca.gov/wood

Base



B G712
9/16 x 7-1/2
MDF 16'



9713 SKIRTBOARD
1/2 x 9-1/4
MDF 10' | 16' | 18'



9623 SKIRTBOARD
1/2 x 9-1/4
MDF 10' | 16'



914E SKIRTBOARD
1/2 x 9-1/4
MDF 10' | 18'

Lengths listed in RED are Extended lead time products - full bundle quantities only

Chair Rail | Panel Mould



5/16
2464
 3/4 X 2
 PRIMED 16'



391
 11/16 X 2-1/4
 PINE RL



L 390
 9/16 x 2-5/8
 MDF **8' | 12'**



L 300
 1 x 2-7/8
 MDF 16'



L 301
 1 x 3-1/4
 MDF 16'



427 (A9)
PANEL MOULD
 9/16 x 1-1/8
 PRIMED 16'

390
 11/16 x 2-5/8
 PINE **8' | RL**
 PRIMED 16'
 19/32 x 2-5/8
 MDF 16'
 5/8 x 2-5/8
 OAK **8' | RL**
 POPLAR RL



260 SHELF EDGE
 11/16 x 1-1/4
 OAK **8'**
 POPLAR **8'**



185
PANEL MOULD
 9/32 x 1-3/8
 PINE RL



L 184
PANEL MOULD
 1/2 x 1-1/2
 PRIMED 16'



2448
PANEL MOULD
 3/4 x 1-1/2
 PRIMED 16'



182
PANEL MOULD
 11/16 x 1-5/8
 PRIMED 16'

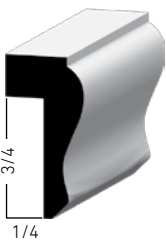

3/4
 1/4
292 PLY CAP
 9/16 x 1-1/8
 PINE **8' | RL**

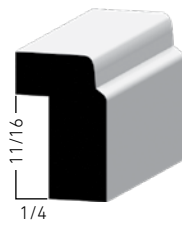

11/16
 1/4
L 294 CAP
 11/16 x 1-1/16
 OAK **8'**



5/16
 1/2
L WCAP
WAINSCOTING CAP
 11/16 x 2
 MDF **8'**

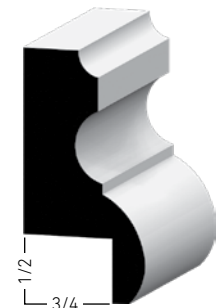

1/2
 3/4
190 PANEL MOULD
 1 x 2
 POPLAR RL

Species listed in RED are Extended lead time products - full bundle quantities only

WARNING: Drilling, sawing, sanding or machining wood products can expose you to wood dust, a substance known to the State of California to cause cancer. Avoid inhaling wood dust or use a dust mask or other safeguards for personal protection. For more information go to www.P65Warnings.ca.gov/wood

Wainscoting | Shiplap



**1X6 EC
WAINSCOTING**
23/32 x 5-1/2
PRIMED 16'
Reversible



**1X4 EC
WAINSCOTING**
23/32 x 3-1/2
PRIMED 16'
Reversible



**L SL16
NICKEL GAP**
5/8 x 5-3/8
PRIMED 16'



**L SL18
NICKEL GAP**
5/8 x 7-3/8
PRIMED 16'



**SL16 TONGUE &
GROOVE SHIPLAP**
11/16 x 5-1/4
MDF 16'



**SL18 TONGUE &
GROOVE SHIPLAP**
11/16 x 7-1/4
MDF 16'



**L WP4
WAINSCOTING**
19/32 x 5
MDF 16'
Reversible



**L SBW4
WAINSCOTING**
19/32 x 5-1/4
MDF 16'

Cove | Bed | Crown

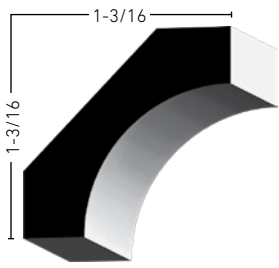

85
9/16 x 1-3/4
PINE **8' | 12'** | RL

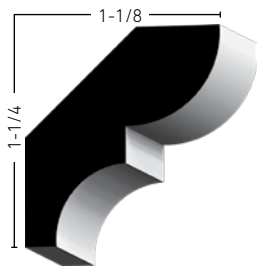

75
9/16 x 1-5/8
PINE RL

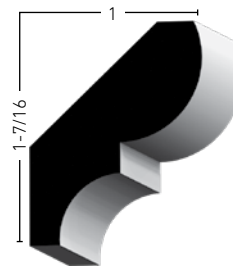

74
9/16 x 1-3/4
PINE RL
PRIMED **8' | 16'**

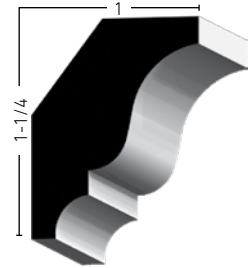

68
9/16 x 1-5/8
PINE RL

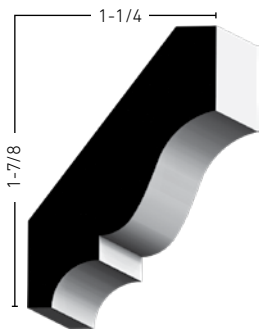

54
9/16 x 2-1/4
PINE **8' | RL**
PRIMED **16'**

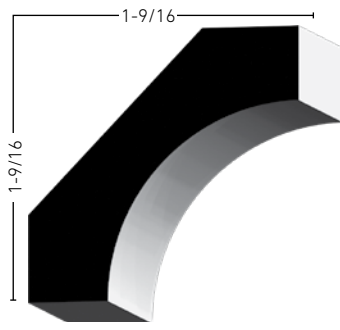

84
9/16 x 2-1/4
PINE RL

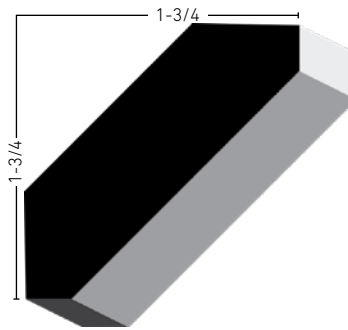

200
11/16 x 2-1/2
MDF **16'**

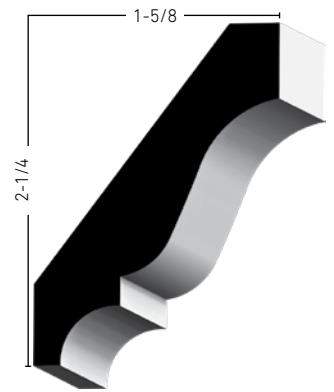

52
9/16 x 2-3/4
PINE RL

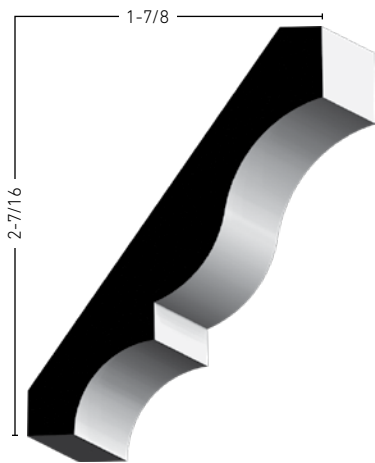

51
1/2 x 3-1/4
OAK RL

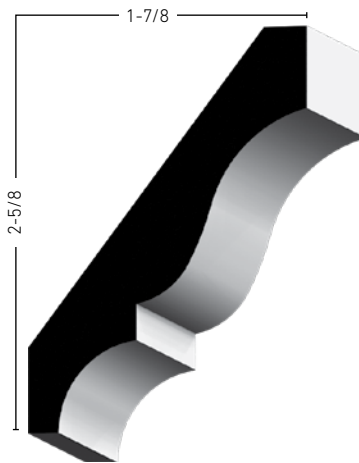

L 51
9/16 x 3-1/4
PINE **12' | RL**
PRIMED **8' | 12' | 16'**

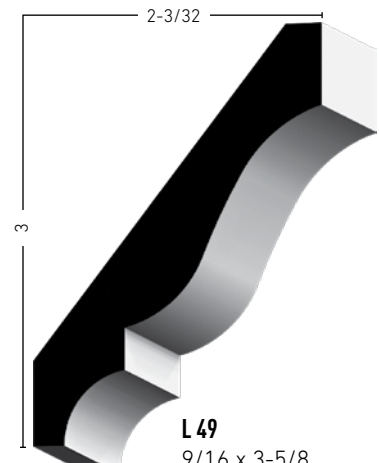

L 49
9/16 x 3-5/8
PINE RL
PRIMED **16'**
MDF **16'**

Species listed in RED are Extended lead time products - full bundle quantities only

WARNING: Drilling, sawing, sanding or machining wood products can expose you to wood dust, a substance known to the State of California to cause cancer. Avoid inhaling wood dust or use a dust mask or other safeguards for personal protection. For more information go to www.P65Warnings.ca.gov/wood

Crown

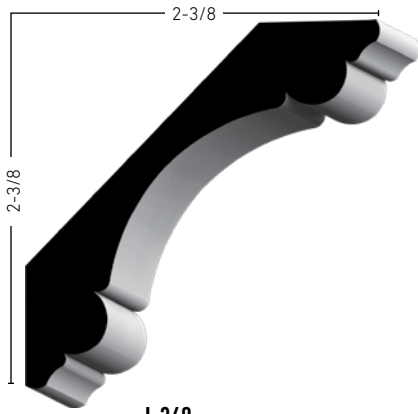

L 340
 $11/16 \times 3-3/8$
MDF 8' | 12' | 16'

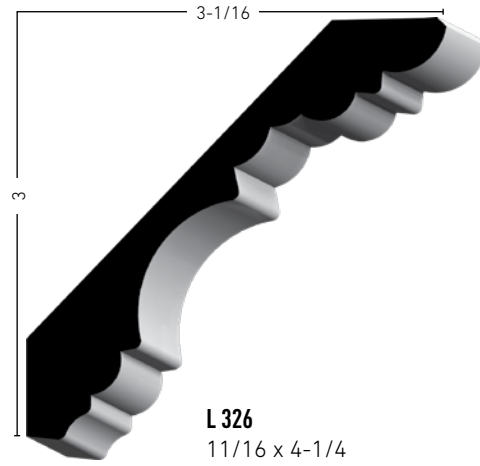

L 326
 $11/16 \times 4-1/4$
MDF 16'

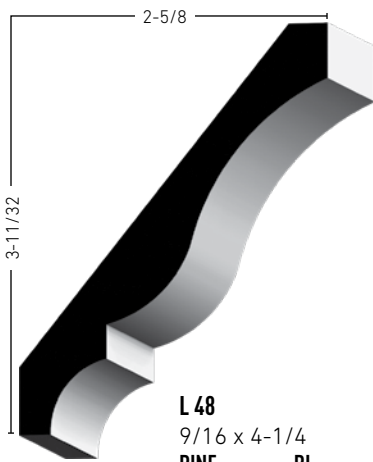

L 48
 $9/16 \times 4-1/4$
PINE RL
PRIMED 16'
 $19/32 \times 4-1/4$
MDF 16'

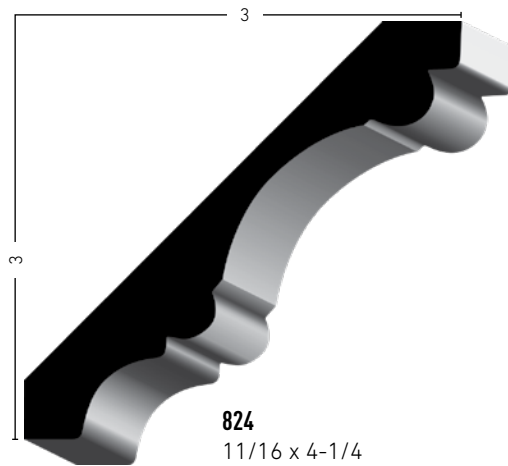

824
 $11/16 \times 4-1/4$
MDF 16'

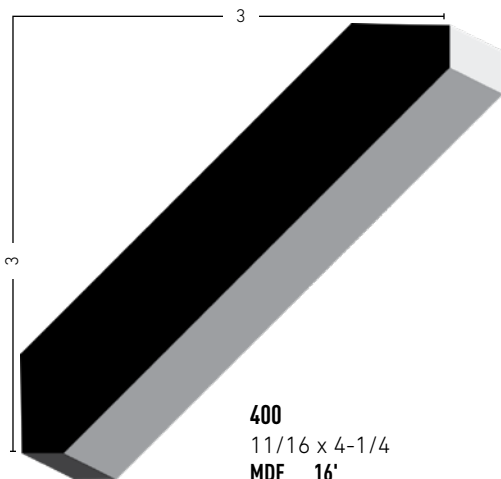

400
 $11/16 \times 4-1/4$
MDF 16'

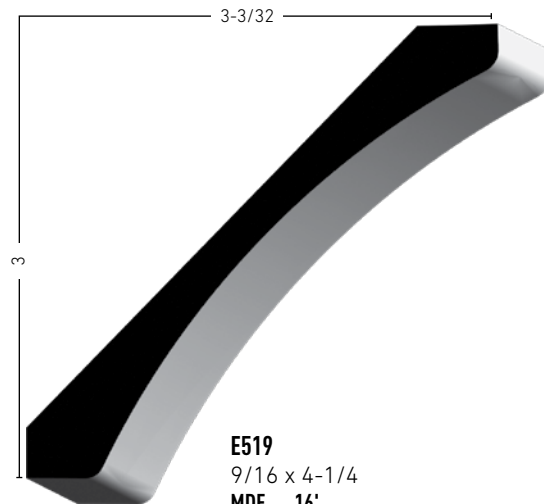

E519
 $9/16 \times 4-1/4$
MDF 16'

Lengths listed in RED are Extended lead time products - full bundle quantities only

Crown

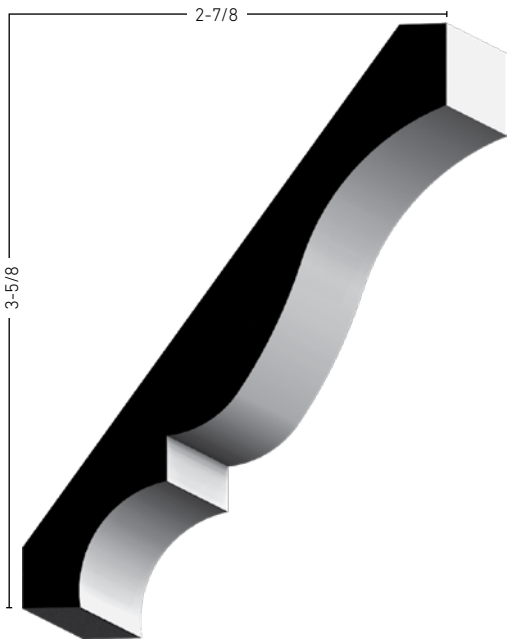

L 47
 $9/16 \times 4-5/8$
PRIMED 8' | 12' | 16'
 $19/32 \times 4-5/8$
MDF 16'

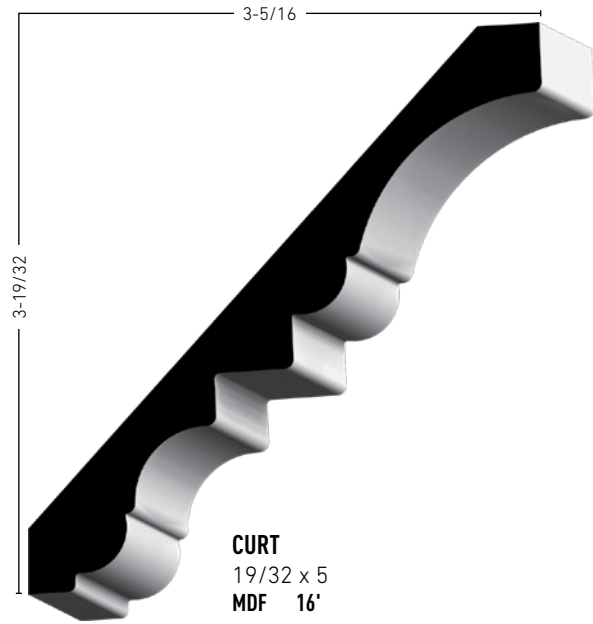

CURT
 $19/32 \times 5$
MDF 16'

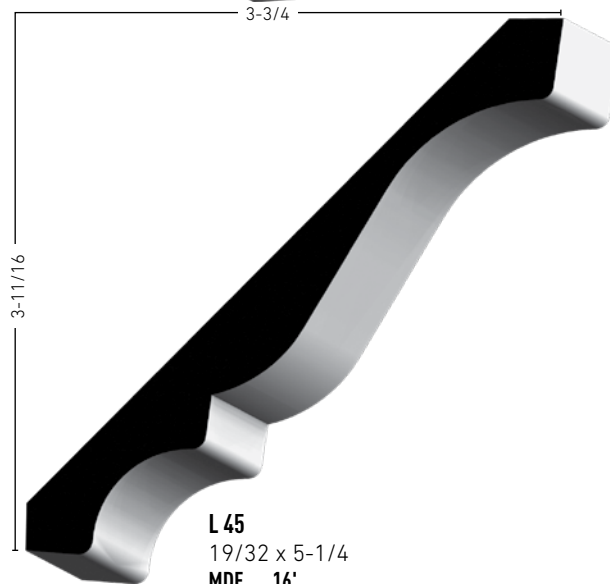

L 45
 $19/32 \times 5-1/4$
MDF 16'

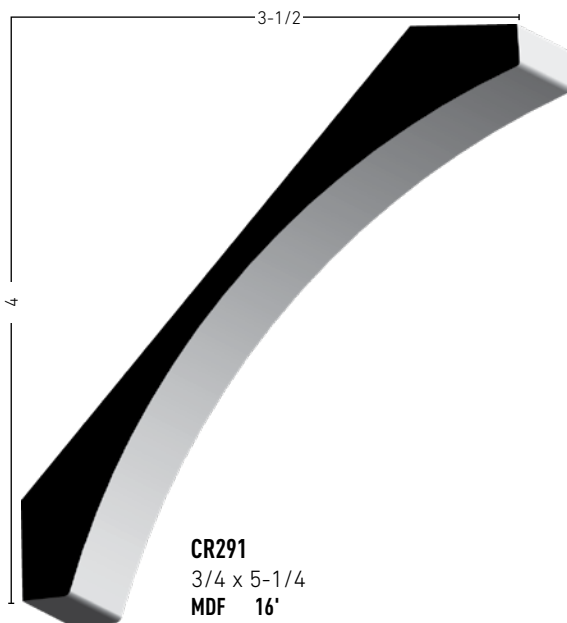

CR291
 $3/4 \times 5-1/4$
MDF 16'

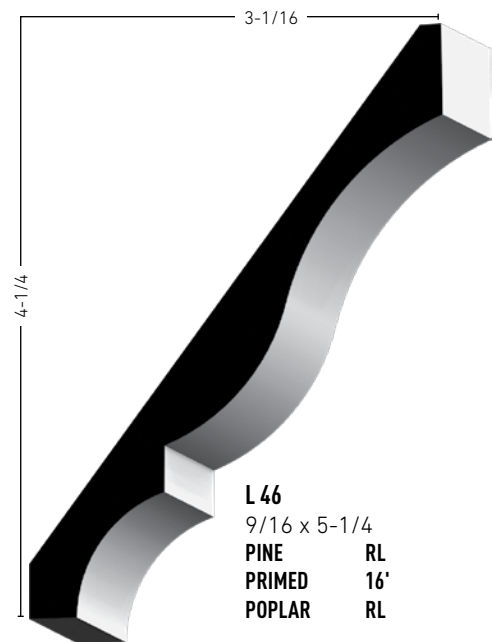

L 46
 $9/16 \times 5-1/4$
PINE RL
PRIMED 16'
POPLAR RL

Species listed in RED are Extended lead time products - full bundle quantities only

WARNING: Drilling, sawing, sanding or machining wood products can expose you to wood dust, a substance known to the State of California to cause cancer. Avoid inhaling wood dust or use a dust mask or other safeguards for personal protection. For more information go to www.P65Warnings.ca.gov/wood

Crown

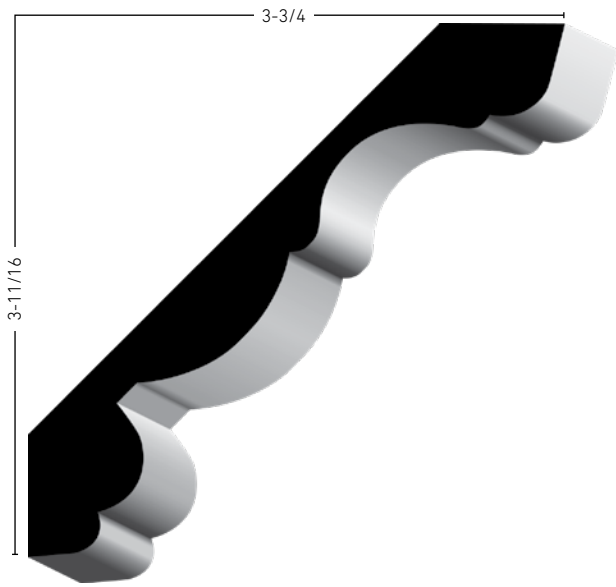

247
 $7/8 \times 5-1/4$
PRIMED 16'

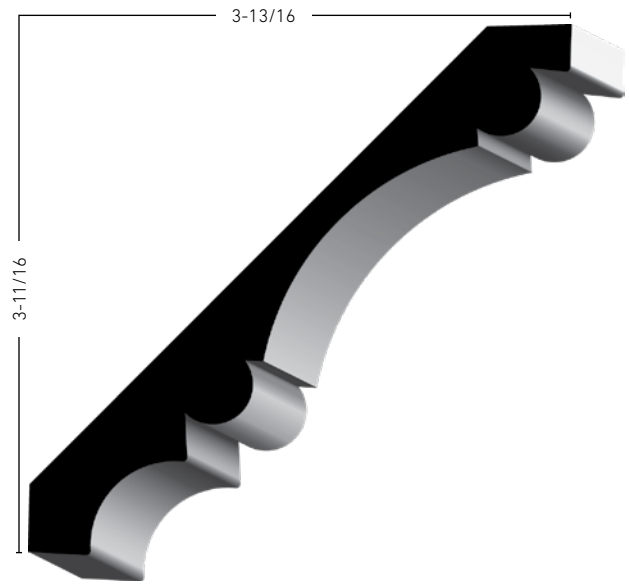

825
 $11/16 \times 5-1/4$
MDF 16'

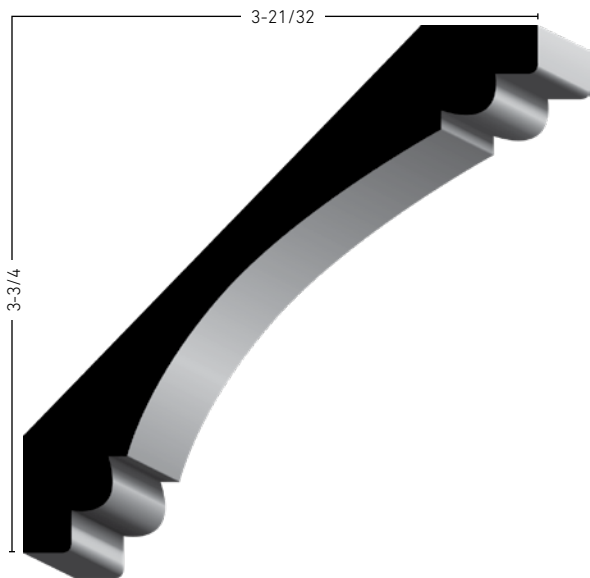

525
 $11/16 \times 5-1/4$
MDF 16'

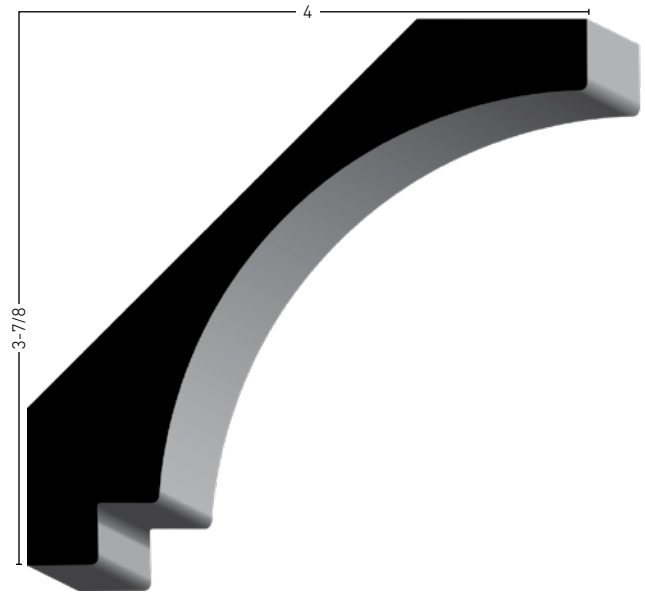

530
 $1-3/16 \times 5-1/2$
MDF 16'

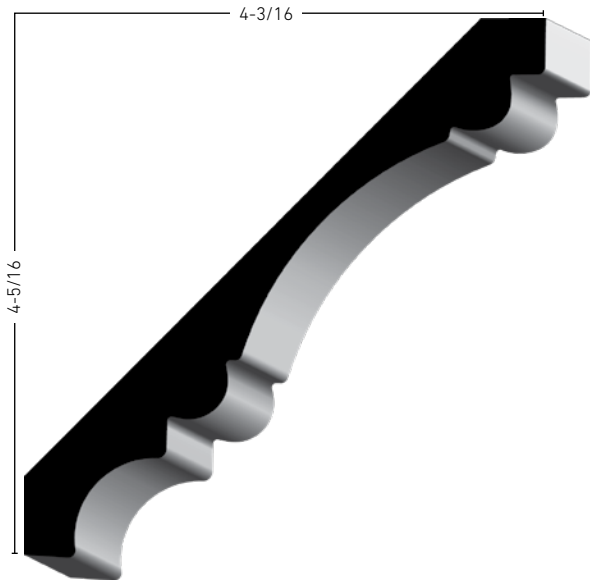

826
23/32 x 6
MDF 16'

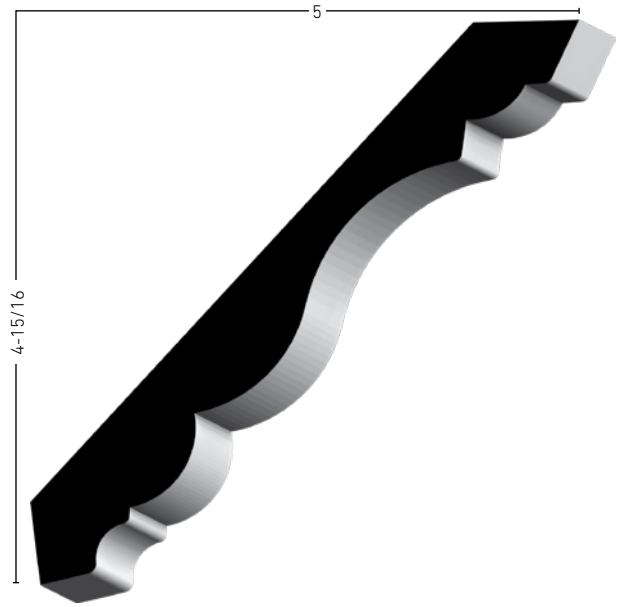

CR75
13/16 x 6-15/16
MDF 16'

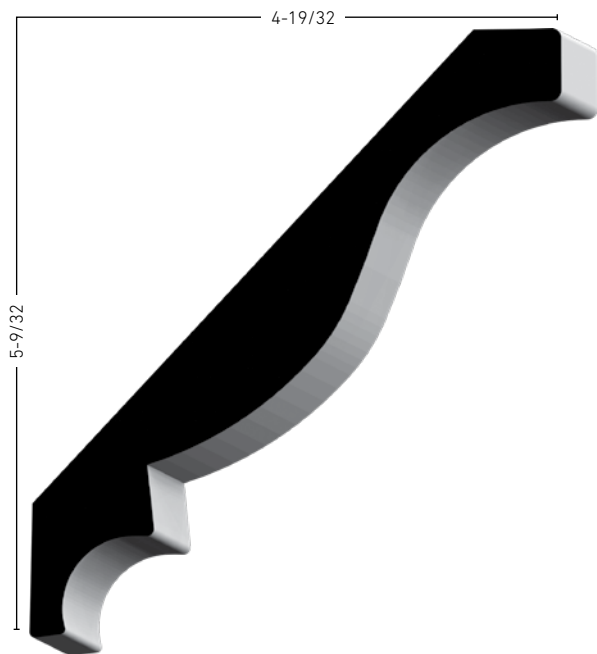

043
1 x 6-15/16
MDF 16'

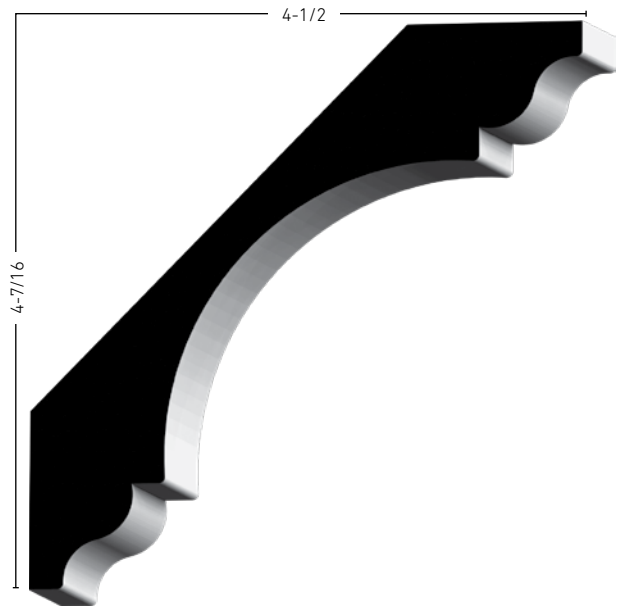

041
1-3/16 x 6-5/16
MDF 16'

Crown

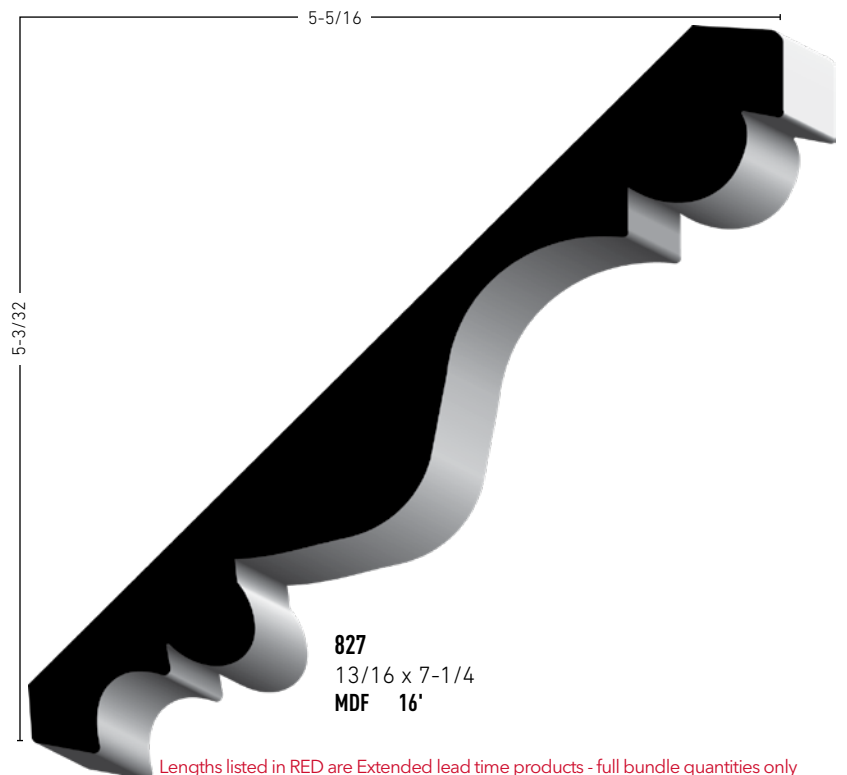
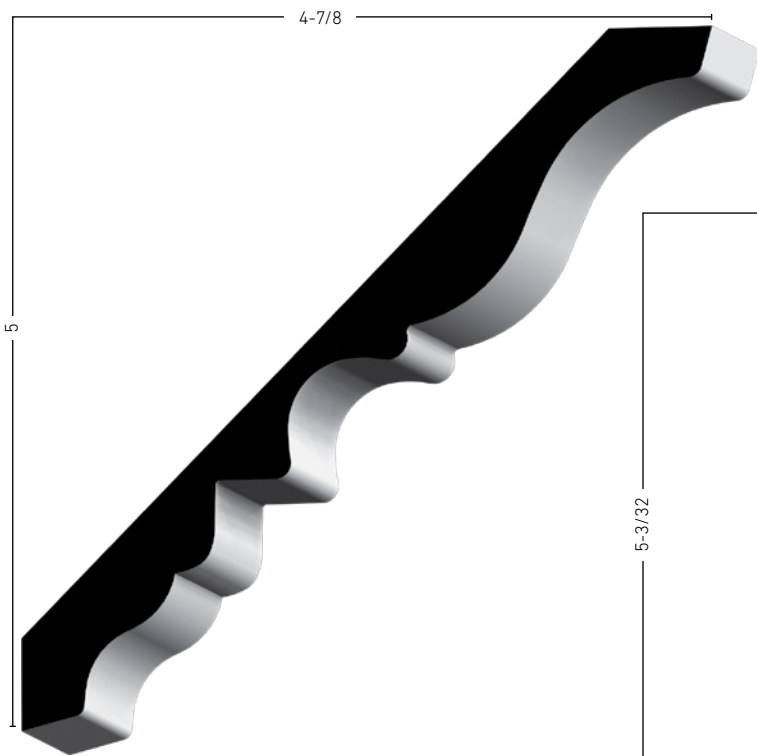
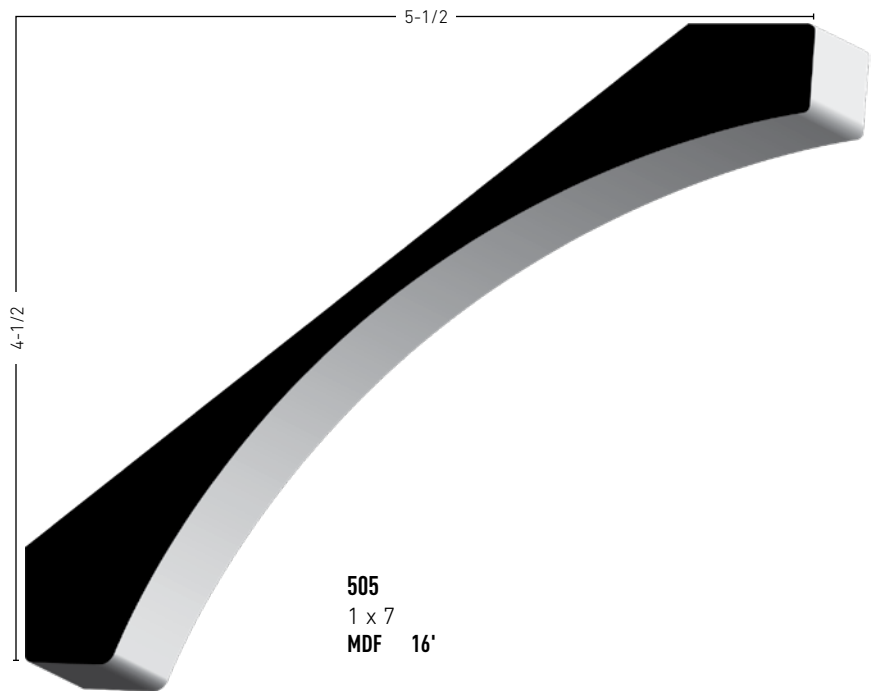
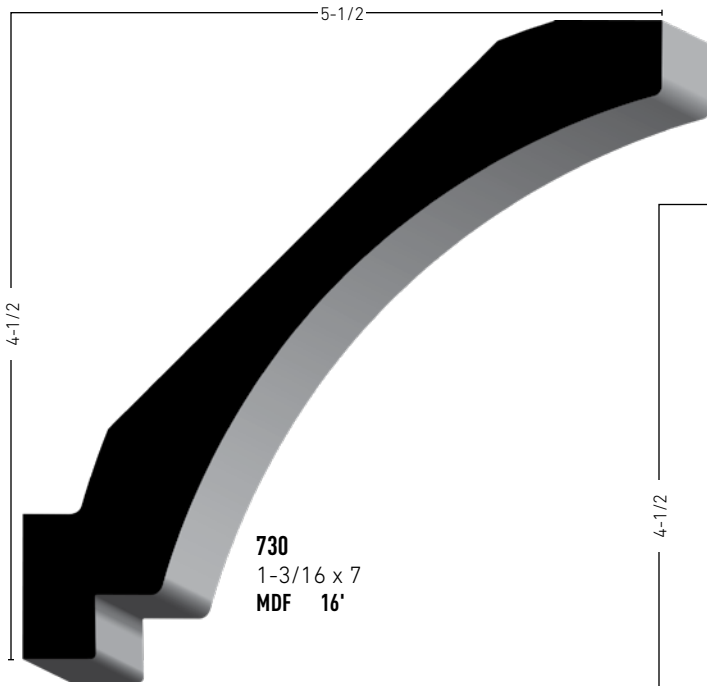

Lengths listed in RED are Extended lead time products - full bundle quantities only

Crown Blocks

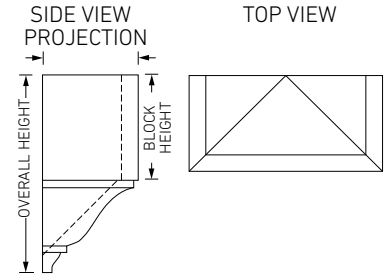
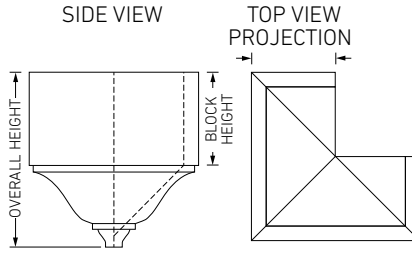
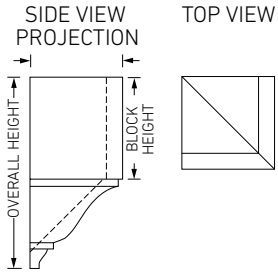

INSIDE CORNER

1897 - SMALL Block Height - 2-3/8
4-1/8 OA-height x 2-1/8 proj. **WHITE WOOD**

1888 - MEDIUM Block Height - 3
5-5/8 OA-height x 2-5/8 proj. **PINE PRIMED**

1898 - MEDIUM Block Height - 3-1/8
5-7/8 OA-height x 2-27/32 proj. **WHITE WOOD**

1899 - LARGE Block Height - 4-3/16
7-3/4 OA-height x 3-11/16 proj. **WHITE WOOD**

OUTSIDE CORNER

1888 - MEDIUM Block Height - 3
5-5/8 OA-height x 2-5/8 proj. **PRIMED**

MIDDLE

1888 - MEDIUM Block Height - 3
5-5/8 OA-height x 2-5/8 proj. **PRIMED**



INSIDE CORNER

1889 - LARGE Block Height - 47-1/2
AO - height x 3-1/2 proj. **PINE**

Species listed in RED are Extended lead time products - full bundle quantities only

WARNING: Drilling, sawing, sanding or machining wood products can expose you to wood dust, a substance known to the State of California to cause cancer. Avoid inhaling wood dust or use a dust mask or other safeguards for personal protection. For more information go to www.P65Warnings.ca.gov/wood

General Purpose

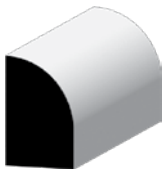

126 SHOE

1/2 x 3/4

PINE 8' | 12' | RL
 PRIMED 12' | 16'
 OAK 8' | 10' | RL
 POPLAR 12' | RL
 POPFP 16'
 MAPLE RL



34 CLOVER LEAF SHOE

3/4 x 3/4

PINE RL
 OAK RL
 PRIMED 16'

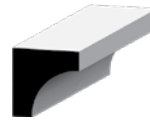

93 COVE

3/4 x 3/4

PINE 8' | RL
 PRIMED 16'
 OAK 8' | RL



L 94 COVE

5/8 x 1-1/8

PINE RL

100

11/16 x 11/16

PINE 8' | RL
 PRIMED 8'
 POPLAR RL



103 QUARTER ROUND

1-1/16 x 1-1/16

PINE RL

105

3/4 x 3/4

PINE 8' | 10' | 12' | RL
 OAK 8' | RL
 PRIMED 16'
 POPLAR RL

106

11/16 x 11/16

PINE 8' | 12' | RL
 PRIMED 8' | 12' | 16'

108

1/2 x 1/2

PINE 8' | RL
 OAK 8'

110

1/4 x 1/4

PINE 8'

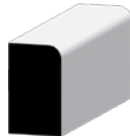

L 254 CRAFTSMAN SHOE

7/16 x 3/4

PRIMED 8' | 12' | 16'
 POPLAR 2L (12' & Longer)
 MDF 16'



B G100 SHOE

5/8 x 1

PRIMED 16'

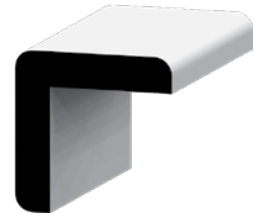

204 CORNER GUARD

1-5/16 x 1-5/16

PINE 8' | RL

205

1-1/8 x 1-1/8

PINE 8' | RL

1-1/16 x 1-1/16

OAK 8'

206

3/4 x 3/4

PINE 8' | RL

OAK 8'



995 CHAMFER

3/4 x 3/4

PINE RL



137 SCREEN MOULD-CLOVER

3/8 x 3/4

PINE 8'



144 SCREEN MOULD-BEADED

1/4 x 3/4

PINE 8'



147 GLASS BEAD

1/2 x 9/16

PINE 8' | RL



123 HALF ROUND

5/16 x 5/8

PINE RL



E 1035 EXTENDED HALF ROUND

1/2 x 1-3/8

MDF 8'
 POPLAR 8' | RL



142 SCREEN MOULD

1/4 x 3/4

PINE 8' | RL

OAK 8'

POPLAR RL



L 210 SHINGLE

5/8 x 1-5/8

PRIMED 8' | 12' | 16'



E 208 SHINGLE

5/8 x 2-1/4

PRIMED 16'



L 197 DRIP CAP

5/8 x 1-5/8

PINE RL

Lengths listed in RED are Extended lead time products - full bundle quantities only

General Purpose

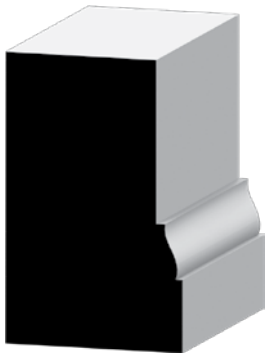

180 BRICK MOULD
1-1/4 x 2
PRIMED 8' | 10' | 17'



L 263 LATTICE
1/4 x 2-1/4
PINE 8'
L 265
1/4 x 1-3/4
PINE 8' | RL
L 266
1/4 x 1-1/2
PRIMED 8'
L 267
1/4 x 1-3/8
PINE 8' | RL
L 268
1/4 x 1-1/8
PINE 8' | RL



L 246 SCREEN STOCK
11/16 x 2-3/4
PINE RL
PRIMED 16'
246
3/4 x 2-3/4
OAK 8'
POPLAR RL
L 248
11/16 x 1-3/4
PINE RL
PRIMED 16'
248
3/4 x 1-3/4
OAK 8' | RL
POPLAR 8' | RL



L 252 BLIND STOP
11/16 x 1-1/4
PINE 8' | RL



254 CHECK STOP
1/2 x 3/4
PINE 8' | RL

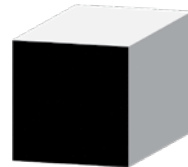

238 SQUARE
1-1/16 x 1-1/16
PINE 8'
239
3/4 x 3/4
PINE 8' | RL

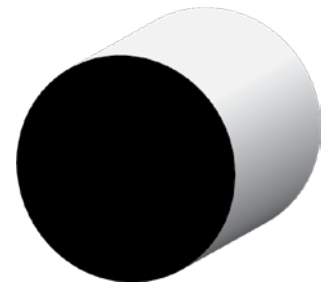

233 CLOSET POLE
1-15/16 Full Round Vinyl
Wrapped Wood
VNLVL 6' | 8' | 10'

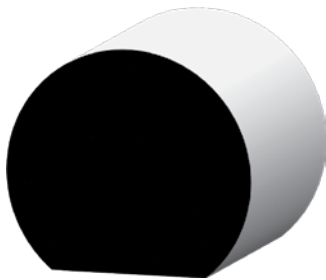

231 HAND RAIL
1-1/2 x 1-11/16
DFIR 12' | 14' | 16' | RL
SPINE 8' | 12' | 16'
POPLAR 16'

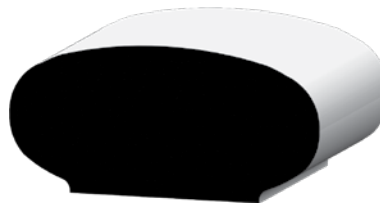

240 HAND RAIL
1-1/4 x 2-1/4
DFIR 16'
SPINE 16'

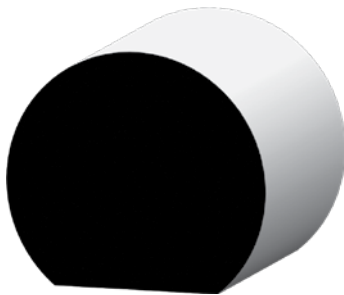

6040 HAND RAIL
1-3/4 x 1-5/8
OAK 8' | 12' | 14' | 16' | 18'
POPLAR 8' | 10' | 12' | 16' | 18'
MAPLE 12' | 16' | 18'
WOAK 16'

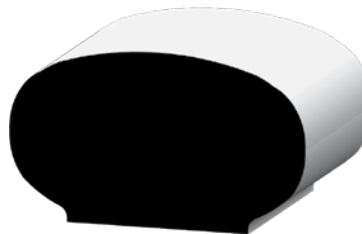

6042 HAND RAIL
2-1/4 x 1-9/32
OAK 8' | 12' | 14' | 16'
POPLAR 10' | 12' | 16' | 18'



L 230 HAND RAIL
1-1/4 x 2
DFIR 16'
1-3/32 x 2
POPLAR 16'

Species listed in RED are Extended lead time products - full bundle quantities only

WARNING: Drilling, sawing, sanding or machining wood products can expose you to wood dust, a substance known to the State of California to cause cancer. Avoid inhaling wood dust or use a dust mask or other safeguards for personal protection. For more information go to www.P65Warnings.ca.gov/wood

Window / Door

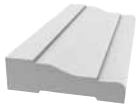

2355 CASING (356)
11/16 x 2-1/4
WHITE 8' | 12'



2449 DRIP CAP
11/16 x 1-5/8
WHITE 12' | 16'



2599 SHINGLE MOULDING
11/16 x 1-5/8
WHITE 8'



7526 BRICK MOULD
1-1/4 x 2
WHITE 8' | 10' | 17'
(3-0 mitered sets available)

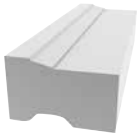

2448 BRICK MOULD (180)
1-1/4 x 2
BROWN 8'



2497 JAMB
3/4 x 5-7/8
PVCGD 7' | 10'



2100 THERMO STOP
7/16 x 1-7/8
WHITE 7' | 9' | 16'



2149 THERMO STOP
7/16 x 2
BROWN 9'
SANDSTONE 9'



2150 STOP
5/8 x 1-1/2
WHITE 12'



2330 BLIND STOP
5/8 x 5/8
WHITE 8'



7788 COLONIAL STOP
3/8 x 1-1/4
WHITE 8'

Floor



2450 BASE CAP
11/16 x 1-1/8
WHITE 8'



7527 BASE
9/16 x 3-1/4
WHITE 8' | 12'



2024 QUARTER ROUND
1/2 x 1/2
WHITE 8'



2689 QUARTER ROUND
3/4 x 3/4
WHITE 8' | 12'



2046 SHOE
5/16 x 3/4
WHITE 8'

Ceiling



2021 COVE
3/4 x 3/4
WHITE 8'



2598 BED MOULD
9/16 x 1-5/8
WHITE 12'



7158 RAMS CROWN
1-13/32 x 2-1/16
WHITE 12'



2435 CROWN
9/16 x 3-5/8
WHITE 12'



7901 SHINGLE PANEL
21/32 x 1-23/32
WHITE 8'



2258 EXTERIOR BEAD
1/2 x 13/32
WHITE 8'

Wall & Trim



N 2878 PANEL
3/8 x 4
WHITE 8'



2352 EXTERIOR PLANKING
3/8 x 5-15/32
WHITE 8'



9825 REVERSIBLE BEADED / V-GROOVE NICKEL GAP PANEL
5/16 x 7-5/16
WHITE 8'



9830 ROYAL CONCEAL NICKEL GAP V-GROOVE SHIPLAP
5/8 x 5-3/8
WHITE 18'



9834 ROYAL CONCEAL NICKEL GAP V-GROOVE SHIPLAP
5/8 x 7-1/8
WHITE 18'



2709 FLAT UTILITY TRIM
5/16 x 5-3/16
WHITE 8' | 12'



7318 (1X4) TRIM PLANK
3/4 x 3-1/2
WHITE 8' | 12'



7311 (1X6) TRIM PLANK
3/4 x 5-1/2
WHITE 8' | 12'



8983 TRIM PLANK
5/8 x 1-1/2
WHITE 8'



9836 CRAFTSMAN CHAIR RAIL / BASE TRIM KIT
5/8 x 2-1/2
WHITE 8'



7719 PVC SMOOTH OS CRNR (WM205)
1-1/8 x 1-1/8
WHITE 8' | 12'

Miscellaneous



2807 RAKE MOULDING
1x2
WHITE 12'



9134 SCREEN MOULD
1/4 x 3/4
WHITE 8'



2018 LATTICE
1/4 x 1-1/2
WHITE 8'

PVC Boards

TRIM BOARD - EMBOSSED / SMOOTH			
7833	1X3	3/4 x 2-1/2	8'
7318	1X4	3/4 x 3-1/2	8' 12'
9767	1X4	3/4 x 3-1/2	18'
7311	1X6	3/4 x 5-1/2	8' 12'
9769	1X6	3/4 x 5-1/2	18'
9770	1X8	3/4 x 7-1/4	18'
9771	1X10	3/4 x 9-1/4	18'
9772	1X12	3/4 x 11-1/4	18'
9775	5/4X4	1 x 3-1/2	18'
9777	5/4X6	1 x 5-1/2	18'
9778	5/4X8	1 x 7-1/4	18'
9779	5/4X10	1 x 9-1/4	18'
9780	5/4X12	1 x 11-1/4	18'

Species listed in RED are Extended lead time products - full bundle quantities only

Moulding Index

Part#	Pg#	Part#	Pg#	Part#	Pg#	Part#	Pg#	Part#	Pg#	Part#	Pg#
3	30	204	54	L 340	8, 48	473	13, 25	P 813	8, 40	4520	26
9 IS	35	205	54	351	25	474	25	P 813 Block	35	4532	25
9 OS	35	206	54	L 356	24	505	12, 52	L P815	42	5010	31
34	54	207	43	356C	24	512	12, 40	P 815	42	5021	31
40	27	E 208	54	356	24	L 512	12, 41	824	48	5030	6, 31
41	6, 51	L 210	54	P358 35	30	512E	12, 41	825	50	6040	55
42	52	227	33	L 361	28	B G512	9, 12, 41	826	51	6042	55
43	51	L 230	55	361	25	B512	12, 41	827	52	7163	42
L 45	49	231	55	L 361C	28	L 512E	12, 41	846	32	8263	42
L 46	49	233	55	B 366	37	G 514	12, 39	856	32	8740	35, 41
L 47	49	L 233	55	L 366	24, 27	L 514	12, 39	857	32	8741	12, 41
L 48	48	238	55	366	24	E519	12, 48	871	30	8920	35
L 49	47	239	55	366A	24	525	50	B 876	32	8951	35
L 51	47	240	55	374	28	530	50	876	32	9623	44
51	47	L 246	55	376	24	535	28	L 887	32	9713	44
52	47	246	55	P 380	26	545	39	887	32	1X4 EC	46
54	47	247	50	L 390	45	SA612	11, 31	887 PB	35	1X6 EC	46
68	47	L 248	55	390	45	L 618	40	892	35	BC14	38
CR75	51	248	55	391	45	618	40	895	35	EDC97	28
74	47	L 252	55	400	12, 48	L 620	37	914E	44	L CC14	27
75	47	L 254	7, 11, 13, 54	410	38	620	37	915	30	CURT	49
84	47	254	55	411	26	623	36	917 PB	35	C PT11	29
85	47	260	8, 45	412	11, 13, 29	L 633	36	935	32	B PT11	38
93	54	L 263	55	E412	13, 29	H 633	37	B 936	32	PT3	26
L 94	54	263	42	G 412	13, 29	L 634	36	936	32	RB3	8, 29
100	54	L 265	55	414E	7, 12, 38	L 635	36	N 946	32	SL16	9, 46
B G100	9, 13, 54	L 266	55	L 414	11, 12, 38	642	30	947	32	L SL16	46
103	54	L 267	55	427	45	658	40	N 947	32	SL18	46
105	54	L 268	55	L 430	12, 38	663	37	972	32	L SL18	46
106	54	279	33	L 431	12, 39	674	40	L 973	32	S RB3	29
108	54	280	7, 9, 11, 13, 33	432	13, 29	682	7, 13, 27	L 983	32	L SBW4	46
110	54	L 433	12, 36	L 433E	11, 12, 36	683	7, 27	995	54	L WCAP	45
123	54	S L433	12, 36	433E	12, 36	685	13, 26	4 1021	33	L WP4	46
126	54	L 434	13, 27	435	12, 38	B G712	44	7 1021	33		
137	54	435	12, 38	438	30	713	37	1021	33	Rustic Collection Shiplap Boards & Trim	10
142	54	438 PB	35	L 444	26	B714	12, 43	E 1035	33, 54	Mantels & Floating Shelves	14
144	54	L 444A	28	444	28	G 714	43	1153	33	Wood Beams	15
147	54	445	27	445A	27	714	36	1200	30	Decorative Boards	16
L 163	35	446	29	P 450	6, 28	714E	7, 12, 43	1305	32	Build-Ups	17
L 163E	6, 39	452	25	452	25	L 723	37	1400	30	Sheet Goods	19-21
163E	39	453	13, 25	453	13, 25	L 724	36	1401 PB	35	Boards	22
163	35	455	27	455A	27	730	52	1402	30	Jamb	34
166	35	456	29	456	29	734	30	1403 PB	35	PVC Moulding	56-57
180	55	L 471	13, 26	465	29	740	30	1888	53		
182	45	472	13, 25	L 471	13, 26	742 PB	35	1889	53		
L 184	45	L 473 Casing	13, 25	472	13, 25	743 PB	35	1892	35		
185	45	L 473 Stop	32	L 473 Casing	13, 25	763	39	1895	35		
190	45			L 473 Stop	32	765	42	1897	53		
L 197	54					795	25	1898	53		
B G200	33					P 805	37	1899	53		
B G250	33					P 808	38	2448	45		
S 200	33					P 808 Block	35	2464	45		
200	47					L P813	40	2496	26		

Quality Products

Boards

- Softwood Boards
- Hardwood Boards
- Interior/Exterior
- S4S & Eased Edged
- Unfinished, Primed
- PVC



Mouldings

- Softwood Mouldings
- Hardwood Mouldings
- Blocks
- Flexible Mouldings

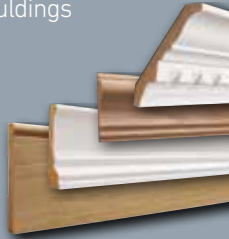

NOVO SHEET GOODS PROGRAM

- Premium Sheets For Hundreds Of Interior Applications
- Wide Selection of SKU Offerings
- Delivered On Your Next Truck Along With Your Moulding And Millwork



Stair Parts

- Wood & Iron Balusters & Newels
- Post to Post Components
- Over the Post Components
- Stock, Special Order, Custom

Cable Systems/Panel Systems

- Marine Grade 316 Stainless Steel
- Swageless Cable Fittings
- Newels Presized & Predrilled
- Preassembled Panels
- Options for Open Tread, Kneewall & Level Run
- Five rake and 7 level panel widths



A NOVO Building Products Company



Decorative Millwork

- Decorative Wood Mouldings
- Mantels, Wood Beams
- Decorative Risers
- Stained Boards

ORNAMENTAL

DECORATIVE MILLWORK

A NOVO Building Products Company

Columns

- Architectural Wood
- Wood Colonial
- Poly-Classic
- Poly-Classic DuraGlass Square
- Poly-Classic Craftsman
- Poly-Classic Porch Posts
- Wood Porch Posts





NOVOBP.COM

Explore our comprehensive collections of mouldings, stair parts, boards, and exterior millwork as well as find inspiration for every room in the home.



Channahon Distribution Center

Route 6 | 23647 W. Eames St.
Channahon, IL 60410

P: 800.253.9000 | F: 800.748.7670

© 2023 NOVOBP, Channahon (Rev. 12/23)

NOVO reserves the right to make changes to the products listed in this catalog without notice and without responsibility for existing units. Drawings may not be to exact scale.

For more information
scan to visit
NOVOBP.COM

