



STAIR PARTS CATALOG

WWW.UNLIMITEDHARDWOODS.COM



HARDWOOD
FLOORING

- UNFINISHED
- PREFINISHED

LAMINATE
& LUXURY
VINYL
FLOORING

TRIMS,
MOULDINGS
& MILLWORK

STAIR
PARTS

CNC
SERVICES

UNLIMITED HARDWOODS SUPPLY
2450 E Oakton St
Arlington Heights, IL 60005

773.873.5073
contact@unlimitedhardwoods.com
quotes@unlimitedhardwoods.com
www.unlimitedhardwoods.com

Located in: Oakton Street Antique Center

Hours:
Monday - Friday 8:00 am - 4:00 pm. Other hours available by appointment.

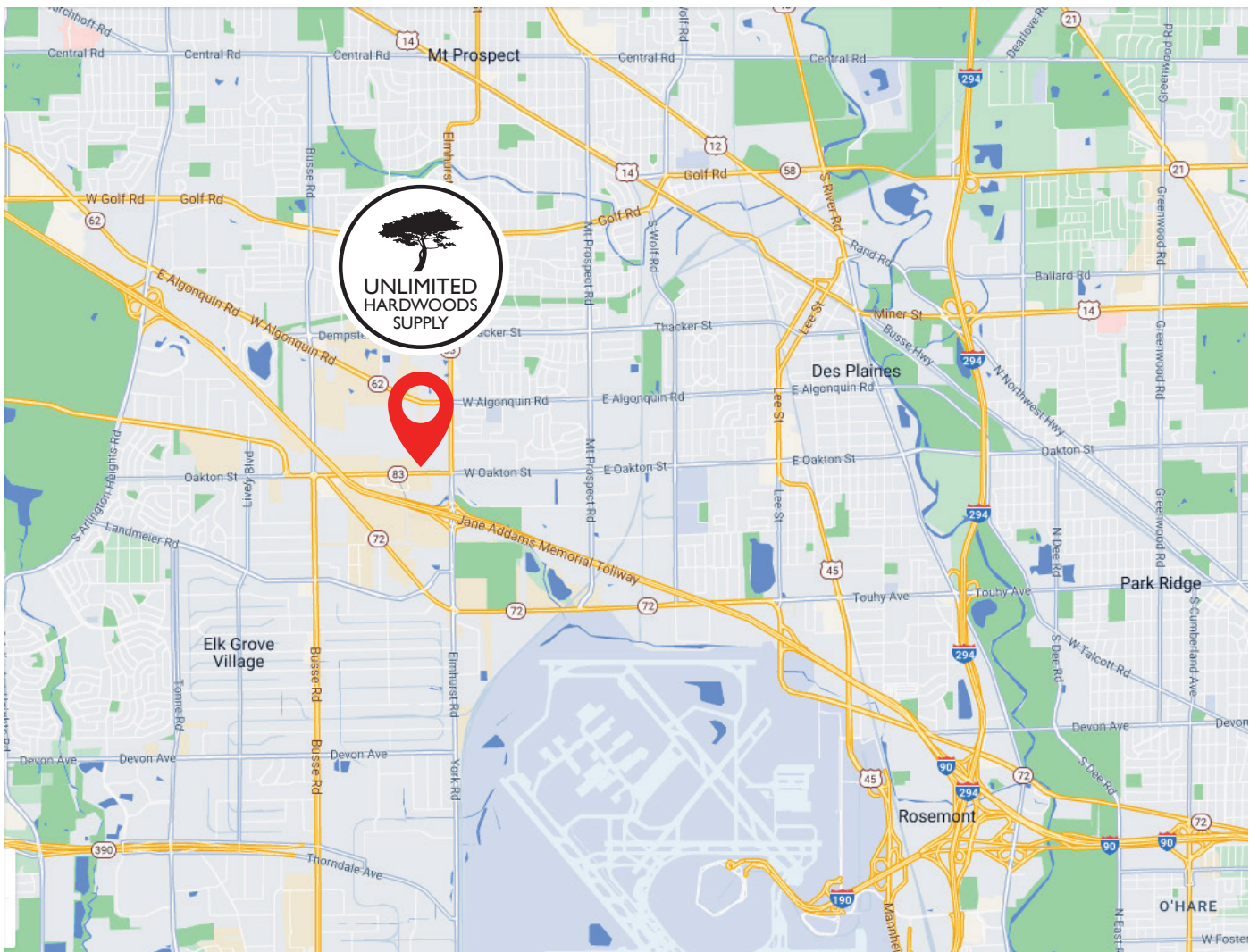
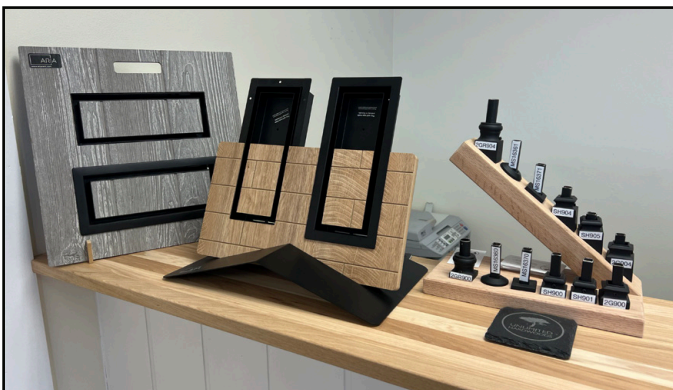

Table of Contents



Traditional Newel Posts	4-5
Modern Newel Posts	6
Box Newel Posts	7
Wood Balusters - 1-1/4"	8
Wood Balusters - 1-3/4"	9
Iron Balusters - 1/2" Square	
Contemporary Iron Balusters	10
Twist Iron Balusters	11
Gothic Iron Balusters: Hammered Face	11
Ribbon Iron Balusters	12
Tuscan Iron Balusters: Hammered Edge	12
Taos Iron Balusters: Hammered Edge	13
Accessories	13
Iron Balusters - 1/2" Round	
Plain, Urn & Ball Iron Balusters	14
Accessories	14
Iron Balusters - 5/8" Square	
Plain & Ribbon Iron Balusters	15
Twist & Basket Iron Balusters	15
Accessories	15
Iron Balusters - 5/8" Round	
Plain, Ribbon & Scroll Iron Balusters	16
Collar, Basket & Ball Iron Balusters	16
Accessories	17
Iron Newel Posts - 1-3/16" Square	17
Stainless Steel Railings	18-19
Wire Cable Railings	20
Accessories	21
Treads & Risers	22-23
Handrails	24
Handrail Fittings	25
Flooring	26
Trims & Moldings	26
CNC Services - Custom Capabilities	27

Newel Posts

3010 - STOCKBRIDGE • Pin Top & Acorn Newels • 3-1/2" Square Base



3010

3042

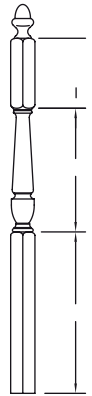
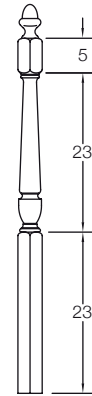
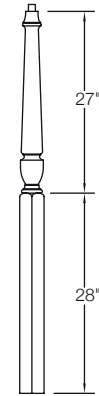
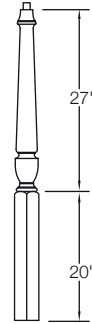
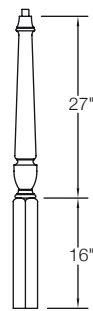
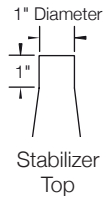

MODEL #	3010PL44	3010PL48	3015PL56	3042PL56
Top	Pin Top	Pin Top	Pin Top	Acorn Top
Length	44"	48"	56"	56"
Bottom	3-1/2"	3-1/2"	3-1/2"	3-1/2"
Species	Red Oak / White Oak / Poplar / Maple* / Cherry* / Brazillian Cherry* / Walnut* / Hickory*			

* Special Order



Newel Posts

4500 - HAMPTON • Pin & Ball Top Newels • 3-1/2" Square Base

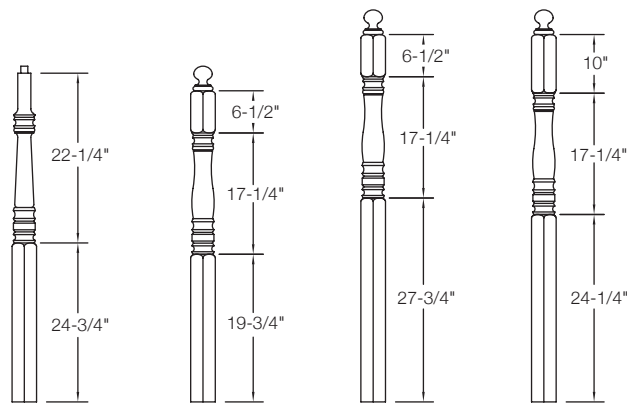
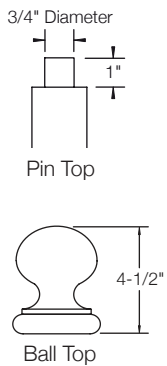

MODEL #	4500PT48	4500BT48	4512BT56	4515BT56
Top	Pin Top	Ball Top	Ball Top	Ball Top
Length	48"	48"	56"	56"
Bottom	3-1/2"	3-1/2"	3-1/2"	3-1/2"
Species	Red Oak / White Oak / Poplar / Maple* / Cherry* / Brazillian Cherry* / Walnut* / Hickory*			
	* Special Order			



950-4 - BORDEAUX • Pin & Ball Top Newels • 3-1/2" Square Base

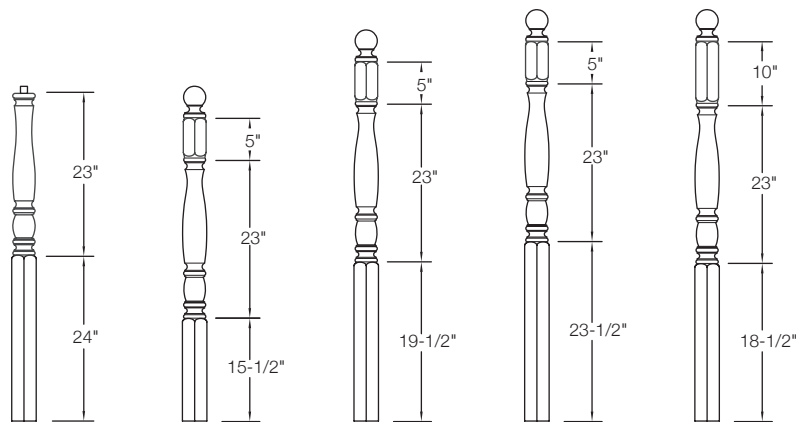
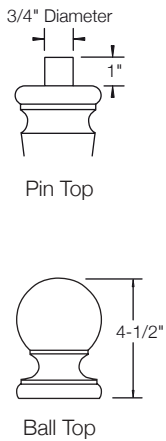

MODEL #	954-4PT48	955-4BT48	955-4BT52	955-4BT56	958-4BT56
Top	Pin Top	Ball Top	Ball Top	Ball Top	Ball Top
Length	48"	48"	52"	56"	56"
Bottom	3-1/2"	3-1/2"	3-1/2"	3-1/2"	3-1/2"
Species	Red Oak / White Oak / Poplar / Maple* / Cherry* / Brazillian Cherry* / Walnut* / Hickory*				
	* Special Order				



Modern Wood Newel Posts

3", 3-1/2" & Bigger Sizes



350B



350RT



350ST



350
Blank



325 GTC

MODEL #	350B	350RT	350ST	350	325GTC/GTB
Top	Line Around	Pin Top	Pin Top	Flat Top	Cap/Beveled Top
Type	Square Blank	Round Tapered	Square Tapered	Square Blank	Custom Profile
Available Sizes	3", 3-1/2" & Bigger*	3", 3-1/2" & Bigger*	3", 3-1/2" & Bigger*	3", 3-1/2" & Bigger*	3-1/2" & Bigger*

Available Species Red Oak / White Oak / Poplar / Maple* / Cherry* / Brazillian Cherry* / Walnut* / Hickory*

* Special Order



325GTC
Cap



325GTB
Beveled

Box Newel Posts

3-1/2", 4-1/2" & 6-1/4" Base

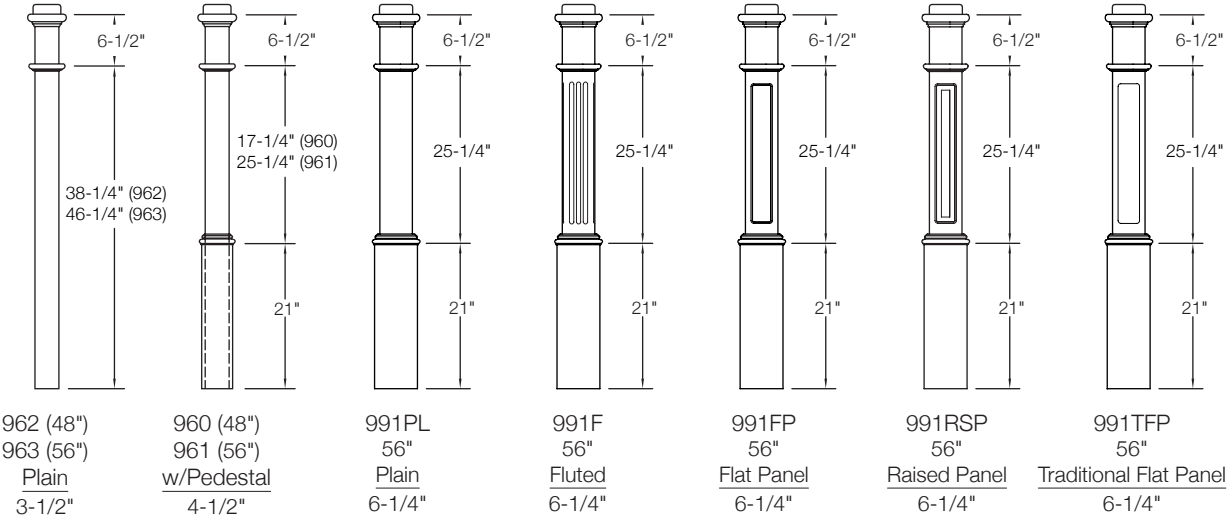

Species Red Oak / White Oak / Poplar / Maple / Cherry* / Brazilian Cherry* / Walnut* / Hickory* * Special Order



"A" Style



"B" Style



"C" Style



"D" Style



900 Style

Wood Balusters

1-1/4" Square & Round Balusters



Blanks Craftsman	100CE Craftsman	5040 Colonial	5015 Colonial	5141 Colonial	5200 Hampton	5205 Hampton	908 Bordeaux	910 Bordeaux	912 Bordeaux
Lengths: - 31" - 36" - 41"	Lengths: - 36" - 41"	Lengths: - 34" - 36" - 39" - 42"	Lengths: - 31" - 34" - 36" - 39" - 41" - 43"	Lengths: - 31" - 34" - 36" - 39" - 41"	Lengths: - 31" - 34" - 36" - 39" - 41"	Lengths: - 31" - 36" - 41"	Lengths: - 31" - 36" - 41"	Lengths: - 36" - 41"	Lengths: - 31" - 36" - 41"



Red Oak
(RO)



Maple
(MAP)



Poplar
(POP)



Cherry
(CHE)



Alder
(ALD)



White Oak
(WO)



Walnut
(WAL)



Hickory
(HIC)



Mahogany
(MAH)

Wood Balusters

1-3/4" Square & Round Balusters



Blanks	2005PL	2015PL	2014	5005	5300	5340	909	911
Craftsman	Stockbridge	Stockbridge	Stockbridge	Hampton	Hampton	Colonial	Bordeaux	Bordeaux
Lengths: - 31" - 36" - 41"	Lengths: - 36" - 41"	Lengths: - 36" - 41"	Lengths: - 31" - 36" - 39" - 41"	Lengths: - 31" - 36" - 41"	Lengths: - 36" - 39" - 41"	Lengths: - 36" - 39" - 41"	Lengths: - 31" - 36" - 41"	Lengths: - 36" - 41"



Red Oak
(RO)



Maple
(MAP)



Poplar
(POP)



Cherry
(CHE)



Alder
(ALD)



White Oak
(WO)



Walnut
(WAL)



Hickory
(HIC)

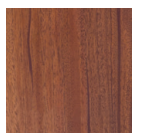

Mahogany
(MAH)

Iron Balusters

1/2" Square Iron Balusters

Contemporary Iron Balusters



T01
Plain



TZZ
Zig Zag



T18
Single
Basket
Slimline



T182
Double
Basket
Slimline



T60
Single
Knuckle



T61
Double
Knuckle



T62
Single
Basket
with
Knuckles



T72
Single
Circle



T73
Double
Circle



T16
Pointed
Oval

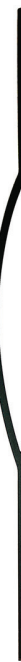

T17
Pointed
Oval



T80
Single
Oval



T81
Single
Rectangle



T82
Double
Rectangle



T83
Triple
Rectangle



T20
Craftsman
Single
Panel



T19
Craftsman
Double
Panel



T813
Rectangular
Panel



T57
"S" Scroll



T85
Double
Helix



T86
Split
Oval



T87
Split
Rectangle

Iron Balusters

1/2" Square Iron Balusters

Twist Iron Balusters

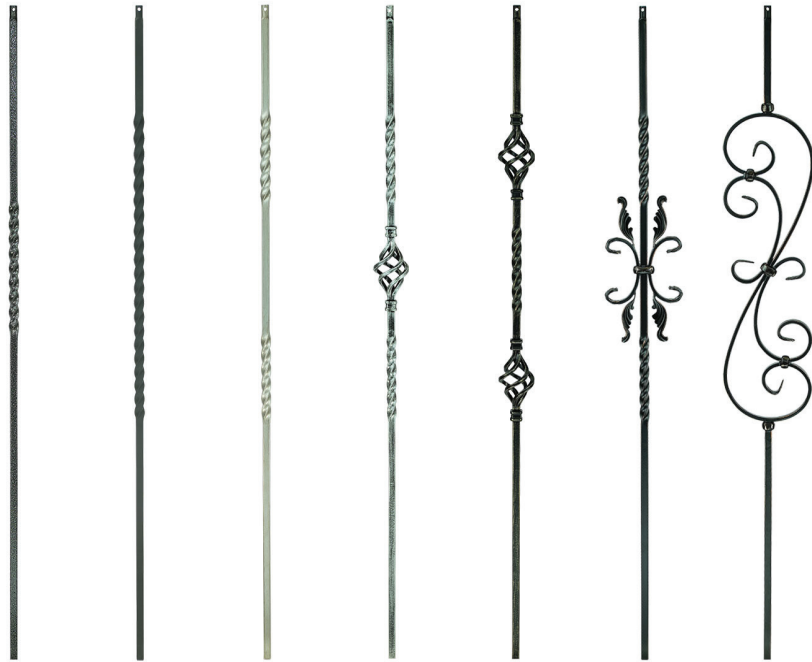

T02
Single
Twist

T27
Single
Twist
20" Long

T03
Double
Twist

T04
Single
Basket

T05
Double
Knuckle

T55
Feather
Scroll

T56
"S" Scroll

Gothic Iron Balusters: Hammered Face



T40
Plain

T41
Single
Knuckle
with Spoons

T42
Double
Knuckle
with Spoons

T43
Single
Basket
with Spoons

T45
Single
Collar
with Spoons

T46
Double
Collar
with Spoons

T47
Single
Basket
with Spoons

Iron Balusters

1/2" Square Iron Balusters

Ribbon Iron Balusters

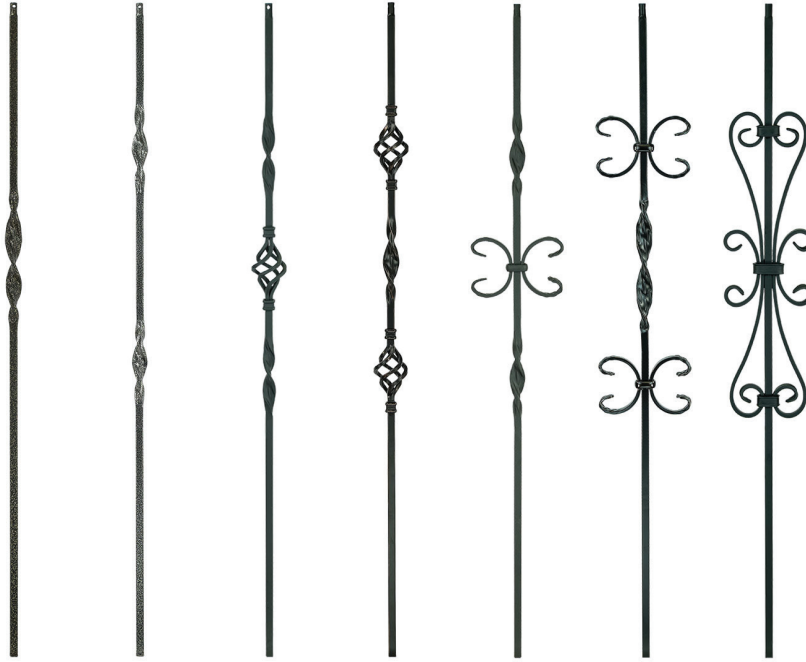

T06
Single
Ribbon

T07
Double
Ribbon

T08
Ribbons/
Single
Basket

T09
Ribbons/
Double
Basket

T10
Ribbons/
Single
Butterfly

T11
Ribbons/
Double
Butterfly

T58
Double
Heart
Scroll

Tuscan Iron Balusters: Hammered Edge

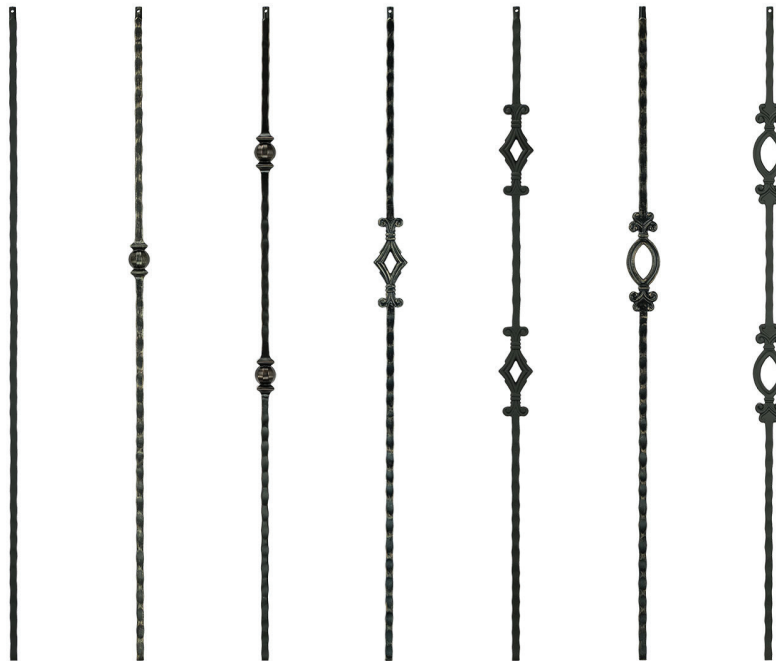

T33
Plain

T31
Single
Ball

T32
Double
Ball

T93
Single
Diamond

T94
Double
Diamond

T95
Single
Oval

T96
Double
Oval

Iron Balusters

1/2" Square Iron Balusters

Taos Iron Balusters: Hammered Edge

Available Iron Finishes

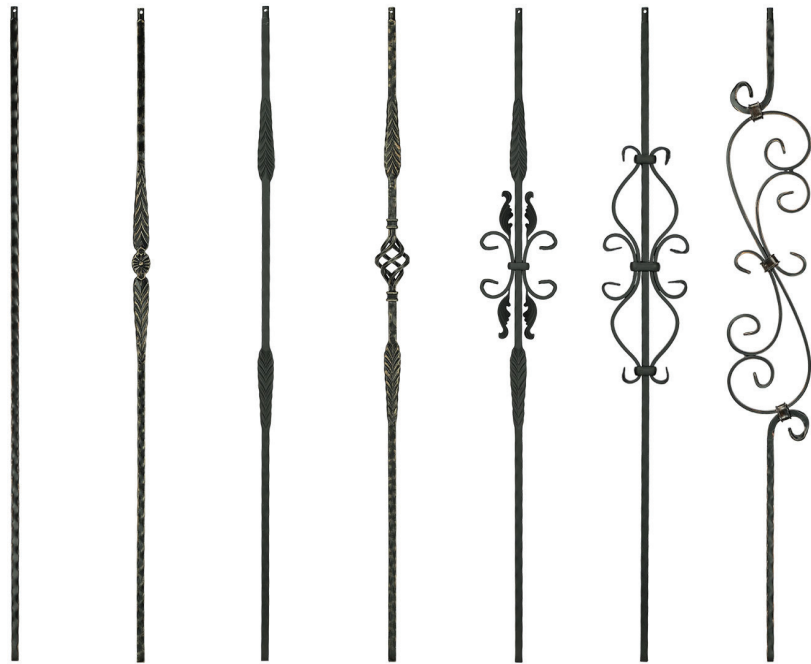

T30 Plain
T21 Flower with Arrows
T22 Split Arrows
T23 Split Arrow with Basket
T24 Split Arrow with Butterfly
T35 "Hour Glass" Scroll
T36 "S" Scroll

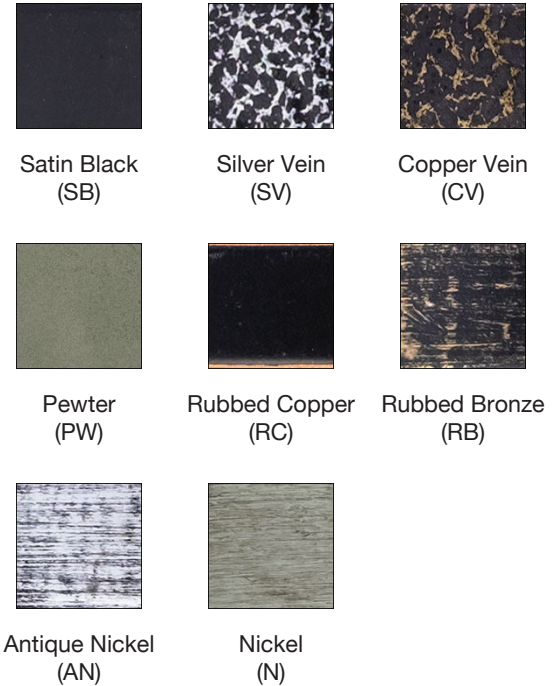

Satin Black (SB)
Silver Vein (SV)
Copper Vein (CV)
Pewter (PW)
Rubbed Copper (RC)
Rubbed Bronze (RB)
Antique Nickel (AN)
Nickel (N)

Accessories



SH800 Flat Shoe no screw
SH804 Slant Shoe no screw
SH900 Flat Shoe with screw
SH904 Slant Shoe with screw
MS16370 Flat Shoe
MS16371 Slant Shoe
SH906 Flat Shoe sidemount screws
SH901 Flat Shoe with screw Hammered
SH905 Slant Shoe with screw Hammered
KN500 Knuckle with set screw
MS16360 Flat Shoe
MS16361 Slant Shoe

Iron Balusters

1/2" Round Iron Balusters

Plain, Urn & Ball Iron Balusters



Accessories



Iron Balusters

5/8" Square Iron Balusters

Plain & Ribbon Iron Balusters



2G01 Plain
2G60 Single Knuckle
2G61 Double Knuckle
2G06 Single Ribbon
2G07 Double Ribbon

Twist & Basket Iron Balusters



2G02 Single Twist
2G03 Double Twist
2G04 Single Basket
2G05 Double Basket
2G56 "S" Scroll

Accessories



2G900
Flat Shoe
with screw



2G904
Slant Shoe
with screw



2GKNCK
Knuckle
with set screws

Iron Balusters

5/8" Round Iron Balusters

Plain & Ribbon Iron Balusters



2GR01
Plain

2GR60
Single
Knuckle

2GR61
Double
Knuckle

2GR04
Single
Basket

2GR05
Double
Basket

2GR06
Single
Ribbon

2GR07
Double
Ribbon

2GR56
"S" Scroll

Collar, Basket & Ball Iron Balusters



2GR10
Single
Collar

2GR20
Double
Collar

2GR11
Single
Basket

2GR12
Double
Basket

2GR18
Single
Basket
Slimline

2GR22
Single
Ball

2GR23
Double
Ball

2GR52
Monaco

2GR51
Monaco
with Urn

Iron Balusters

5/8" Round Iron Balusters

Accessories



2GR900
Flat Shoe
with screw



2GR904
Slant Shoe
with screw



2GRKNCK
Knuckle
with set screws



C1
Knuckle
with set screws



C2
Knuckle
with set screws

Iron Newel Posts

1-3/16" Square Iron Newels



TN01
Plain



TN04
Single Basket



TN33
Plain
Hammered
Edge



TN31
Single Ball
Hammered
Edge



TN60
Single Knuckle



2GR06
Single
Ribbon

Stainless Steel Railings

Railings System



SS101
90° Square Elbow
304 Stainless Steel
Tube Size: 40x40x2mm
Satin Polish Finish



SS102
90° Square Adjustable Elbow
304 Stainless Steel
Tube Size: 40x40x2mm
Satin Polish Finish



SS103
90° 3 Way Square Elbow
304 Stainless Steel
Tube Size: 40x40x2mm
Satin Polish Finish



SS104
180° Square Union Connector
304 Stainless Steel
Tube Size: 40x40x2mm
Satin Polish Finish



SS105
Square End Cap
304 Stainless Steel
Tube Size: 40x40x2mm
Satin Polish Finish



SS106
Square 3-way "T" Connector
304 Stainless Steel
Tube Size: 40x40x2mm
Satin Polish Finish



SS107
Square Flange Cover
304 Stainless Steel
Tube Size: 40x40x2mm
Satin Polish Finish



SS108
Square Wall Flange Base
304 Stainless Steel
Tube Size: 40x40x2mm
Satin Polish Finish



SS100
39" Square Tube w/Welding Base
304 Stainless Steel
Tube Size: 40x40x2mm
Satin Polish Finish



SS100WB
Welding Base for 40X40 Square Tube
304 Stainless Steel
Tube Size: 40x40x2mm
Satin Polish Finish



SSTSQ40
40mm Square Tubing
304 Stainless Steel
2 mm Wall
Satin Polish Finish



GC55SQ
Square Glass Clamp
304 Stainless Steel
Channel: 3/8" Glass (standard)
Channel: 1/2" Glass (available)



SSTR12
1/2" Round Tubing
304 Stainless Steel
.065" Wall



SSTR58
5/8" Round Tubing
304 Stainless Steel
.065" Wall



SSTR34
3/4" Round Tubing
304 Stainless Steel
.065" Wall



SSTR42
42.4 mm Round Tubing
304 Stainless Steel
.065" Wall



SS901
1/2" Round Through Bar Holder
304 Stainless Steel
Back: Flat
Satin Polish Finish



SS902
1/2" Round Ending Bar Holder
304 Stainless Steel
Specify: LH or RH Set Screws
Satin Polish Finish



SS903
1/2" Round Tube Ending Sphere
304 Stainless Steel
Ball Diameter: 30mm
Satin Polish Finish



SS908
5/8" Round Tube Through Sphere
304 Stainless Steel
Ball Diameter: 30mm
Satin Polish Finish



SS910
180° Flat Saddle
304 Stainless Steel
Top & Bottom Views Shown
Satin Polish Finish



SS911
90° Flat Saddle
304 Stainless Steel
Top & Bottom Views Shown
Satin Polish Finish



SS912
135° Flat Saddle
304 Stainless Steel
Top & Bottom Views Shown
Satin Polish Finish



SS110
Stand Up Square Adjustable Bracket
304 Stainless Steel
Tube size: 40x40x2 mm
Satin Polish Finish



SS920
180° Round Saddle
304 Stainless Steel
Top & Bottom Views Shown
Satin Polish Finish



SS921
90° Round Saddle
304 Stainless Steel
Top & Bottom Views Shown
Satin Polish Finish



SS922
135° Round Saddle
304 Stainless Steel
Top & Bottom Views Shown
Satin Polish Finish

Wire Cable Railings



Stealth Dome
(Hand Swage)
316 Stainless Steel
For 1/8" Wire Cable
Available in black color



Stealth Receiver
316 Stainless Steel
For 1/8" Wire Cable
Available in black color



Stealth Stud
316 Stainless Steel
For 1/8" Wire Cable
Available in black color

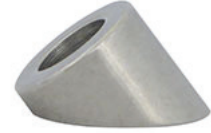

Angle Washer
316 Stainless Steel
For 1/8" Wire Cable
Available in black color



SS18WIRE
Stainless Steel Wire Cable
1/8" Diameter



SS18WIRESB
Stainless Steel Wire Cable
1/8" Diameter



Lag Studs
(LH and RH thread)
Stainless Steel
For 1/8" Wire Cable
Available in black color



Protective Sleeve
Stainless Steel
For 1/8" Wire Cable
Available in black color

Accessories



3002HD
Wall Handrail Bracket
2-3/8" Zinc Alloy
Handrail Bracket



3003
Wall Handrail Bracket
2-3/4" Zinc Alloy
Handrail Bracket



3003LA
Wall Handrail Bracket
3-1/8" Zinc Alloy
Handrail Bracket



3004
Wall Handrail Bracket
2-3/4" Solid Brass
Handrail Bracket



UH174002
Wall Handrail Bracket
Adjustable
304 Stainless Steel



UH174001
Post Handrail Support
for Wood Posts
304 Stainless Steel



SQ212
Wall Handrail Bracket



Rail Bolt Kits
Rail Bolts
Dowel Screws
Hanger Bolts



7017
4" Round Rosette



7033
4-1/2" x 6" Rectangular Rosette



7037
4" x 5-1/4" Oval Rosette



Wood Plugs
Face Grain Plugs
3/8", 1/2", 5/8" 1"

Treads



8070



8070SQ

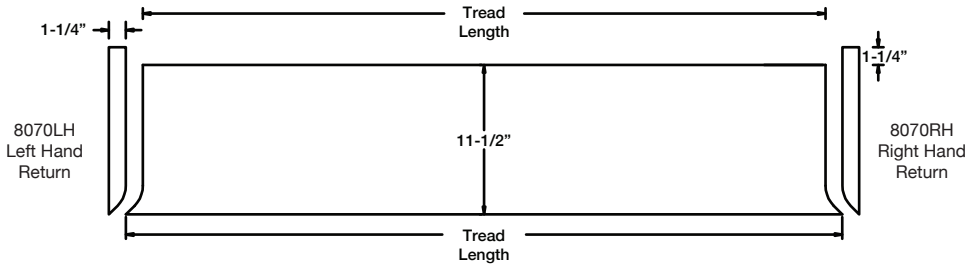

Treads with returns on both sides available.

8070 - Tread with 1/2" Radius Rounded Bullnose
Solid, Straight Tread
11-1/2" x 36", 42", 48", 54", 60", 72" and up to 16 ft

8070SQ - Tread with 1/8" Eased Square Edge
Solid, Straight Tread
11-1/2" x 36", 42", 48", 54", 60", 72" and up to 16 ft



8071

Solid Tread with Front - up to 4" thick
11" x 42", 48", 54", 60" and bigger
Available with both side returns or without returns

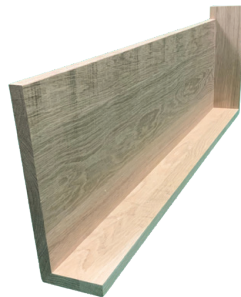

8071

Solid Tread with Front - up to 4" thick
(side view)



8072

Box Tread - up to 4" thick
11" x 42", 48", 54", 60" and bigger
Available with both side returns or without returns.
Available with groove for LED lights.



8073

Sandwich Lamination Style
Solid Tread - up to 4" thick
11" x 42", 48", 54", 60" and bigger



8074

Butcher Block Lamination Style
Solid Tread - up to 4" thick
11" x 42", 48", 54", 60" and bigger



8072

Box Tread - up to 4" thick
(side view)

Treads & Risers



8075
Winder Treads
36" x 36", 42" x 42", 48" x 48"
and other sizes available



8075
Winder Treads
36" x 36", 42" x 42", 48" x 48"
and other sizes available



8078
Risers
3/4" x 36", 42", 48", 54", 60"
and other sizes available

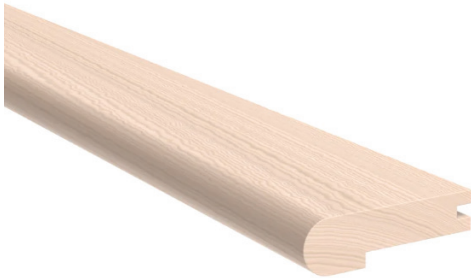

8093
3-1/2" Nosing - Landing Tread
Rounded Bullnose

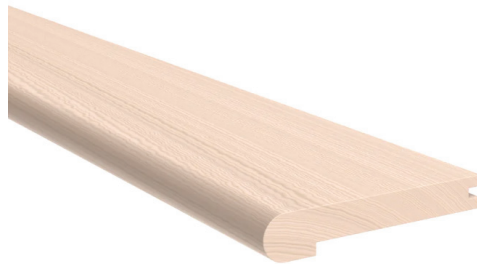

8095
5-1/2" Nosing - Landing Tread
Rounded Bullnose



8110
Starting Step with 1 end
Rounded Bullnose



8093SQ
3-1/2" Nosing - Landing Tread
Square Edge. 1/8" radius



8095SQ
5-1/2" Nosing - Landing Tread
Square Edge. 1/8" radius



8112
Starting Step with 2 ends
Rounded Bullnose

Wood Handrails



6002
2-3/4" x 1-5/8"



6084
2-5/8" x 1-5/8"



6010
2-1/4" x 2-3/8"
1-1/2" Bottom



6210
2-5/8" x 2-3/8"
2-1/4" Bottom



6710
2-5/8" x 2-3/4"
2" Bottom



6910
2-5/8" x 2-5/8"
2-1/4" Bottom



8000
2-1/4" x 2-1/4"
2-5/8" Bottom



8200
2-5/8" x 2-1/4"
2-5/8" Bottom



8500
2-5/8" x 2-3/8"
2-3/8" Bottom



9100
2" x 2-3/8"
2-1/4" Bottom



9500
1-15/16" x 1-5/8"



6050F
1-1/4" Fillet



6052
1-3/4" Fillet



6040
1-3/4" x 1-5/8"
7/8" Bottom



6042
2-1/4" x 1-1/4"
3/4" Bottom



8100
2" x 1-3/4"
2" Bottom

Handrail Fittings



Returned End (09)



Starting Easing with Cap (10)



Level Qtr Turn 90° (11)



Level Qtr Turn 135° (11-135)



Up Easing (12)



Over Easing 60° (13)



Up Easing 90° (14)



Opening Cap (19)



"S" Turn 10" Arms - LH/RH
(15LH / 15RH)



Tandem Cap (20)



1/4 Turn with Cap 90° (21)



1/4 Turn with Cap
135° (21-135)



Volute Flat - LH/RH
(30LH / 35RH)



Volute Vertical (38)



Turnout Large - LH/RH
(40LH / 45RH)

Flooring

UNFINISHED
HARDWOOD
FLOORING

PREFINISHED
HARDWOOD
FLOORING

ENGINEERED
HARDWOOD
FLOORING

LAMINATE
FLOORING

LUXURY
VINYL
FLOORING

Trims & Moldings

BASEBOARD

CASING

CROWN

ARCHITRAVES

BACK BANDS

BASEBOARD
CAPS & SHOES

CHAIR RAILS

COVES

DOOR STOPS

PANEL
MOULDINGS

PLINTH
BLOCKS

SCREEN
MOULDINGS

STOOLS

TONGUE
& GROOVE
PANELING

MISCELLANEOUS

CNC Services - Custom Capabilities

- 1 Curved Landing Tread
- 2 Shaped Landing Tread
- 3 Shaped Handrail
- 4 Curved Handrail
- 5 Curved Fascia Moulding
- 6 Curved Treads
- 7 Curved Cove Moulding
- 8 Bowed Treads
- 9 Bowed Risers
- 10 Bowed Starting Tread
- 11 Stacked Starting Tread
- 12 Curved Tread Return
- 13 Custom Box Newels
- 14 Custom Turned Newels - from 3-1/2" to 8"
- 15 Custom Turned Balusters
- 16 Custom Fittings
- 17 Custom Stringers
- 18 Replication / Copy of Existing Elements
- 19 CNC Machining
- 20 Templating / Laser Measurements

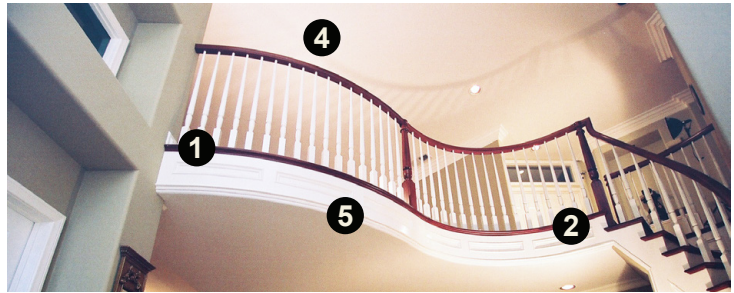



Address:
2450 E Oakton St
Arlington Heights, IL 60005

Phones:
773.873.5073
773.234.5054

Hours:
Monday - Friday
8 am - 4 pm
Other hours available by appointment.

WWW.UNLIMITEDHARDWOODS.COM